

VOLUME 1
electronic copy



TECHNICAL PROPOSAL
I-81 Bridge Replacement at Exit 114
A Design-Build Project

State Project No.: 0081-154-733, R201, C501, B601, B616
Federal Project No.: NHPP-081-2(992)
Contract ID Number: C00093074DB96



Submitted by:
Haymes Brothers, Inc.
In association with:
A. Morton Thomas and Associates, Inc.



4.1 Letter of Submittal



440 Hawkins Road
Chatham, Virginia 24531
Phone (434) 432-8282
Fax (434) 432-2029

March 2, 2018

RE: **TECHNICAL PROPOSAL**
I-81 Bridge Replacement at Exit 114
Montgomery County,
Town of Christiansburg, VA)
State Project No. 0081-154-733, R201,
C501, B601, B616
Contract ID No.: C00093074DB96
Federal Project Nos: NHPP-081-2(992)

Virginia Department of Transportation (VDOT)
1401 East Broad Street
Richmond, VA 23219
Attn: Stephen D. Kindy, PE (APD Division)

Dear Mr. Kindy:

Haymes Brothers, Inc. (Haymes Brothers Team), along with our Design-Build Team (DB Team), is pleased to submit one (1) original and nine (9) copies of our Technical Proposal, Volumes I and II, and one (1) CD-ROM containing the entire Technical Proposal in a PDF file to provide design-build services for the I-81 Bridge Replacement project. The Haymes Brothers Team acknowledges receipt of the RFP, and Addenda 1, as documented by form C-78-RFP included in the Appendix (Section B) of this proposal.

As requested in section 4.1 of the RFP, the Haymes Brothers Team offers the following information:

- 4.1.2 Intent to Enter in Contract:** If selected, it is the intention of Haymes Brothers Team to enter into a contract with VDOT for the Project in accordance with the terms of the RFP.
- 4.1.3 Proposal Validity:** Haymes Brothers Team declares that the offer represented by the technical and price proposal will remain in full force and effect for 120 days after the proposal due date of March 2, 2018.
- 4.1.4 Point of Contact:** Henry A. Haymes, Vice President, Haymes Brothers, Inc., 440 Hawkins Road, Chatham, VA 24531; (p) 434.432.8282 (f) 434.432-2029 (e) Haymes@haymesbrothers.com
- 4.1.5 Principal Officer:** Henry A. Haymes, Vice President, Haymes Brothers, Inc., 440 Hawkins Road, Chatham, VA 24531; (p) 434.432.8282 (f) 434.432-2029 (e) AHaymes @haymesbrothers.com
- 4.1.6 Final Completion Dates:** Pursuant to the RFP date set forth in Part 1, Section 2.3.1, Haymes Brothers Team commits to a final completion date of July 19, 2021.
- 4.1.7 Proposal Payment Agreement:** Signed and included in the appendix is the form set forth in Attachment 9.3.1.
- 4.1.8 Certification Regarding Debarment:** Signed and included in the appendix is the form set forth in Part 1, Section 11.8.6.

The Haymes Brothers Team is 100% committed to delivering a successful quality project to VDOT on-time and on-budget. We appreciate the opportunity to submit our technical proposal to you and look forward to being selected to exceeding it expectations for quality of the design and construction of the I-81 Bridge Replacement Project. If you have any questions or need further information, please contact me.

Respectfully submitted,

Haymes Brothers, Inc.

enr A. a mes

4.2 Offero 's Qualification

4.2 OFFEROR'S QUALIFICATIONS

4.2.1 SOQ Confirmation

The information in our Statement of Qualifications dated September 6, 2017 remains true and accurate. There have been no changes to our team's organizational framework, lead contractor, lead designer, key personnel or other individuals identified in our Statement of Qualifications since its submission that would warrant prior VDOT written approval.

4.2.2 Organization Chart & Narrative

a. Organizational Chart

The Haymes Brothers Team organization chart shown below illustrates our reporting and functional structure and notes the key and support personnel. Although there have been no changes to our Key Personnel, we have made the following modifications to the support personnel and organizational chart, as highlighted below, and described further in the narrative.

We propose Michael Glickman, PE, PTOE, MOT/Traffic Engineer as the replacement for Charlie O'Connell whom is no longer employed with AMT. Mr. Glickman will be responsible for all traffic control device design along with Maintenance of Traffic (MOT) plans. He has over 22 years of experience of traffic engineering experience supporting the design of roadway improvements that enhance the operational efficiency and safety of interchanges, intersections and roadways and has served as the Lead Traffic Engineer for the I-81 at Exit 310 Interchange (Route 37) in Winchester, Virginia, the Martin Luther King Expressway Extension in Portsmouth, Virginia and the US 15/17/29 at Lord Fairfax Road Interchange in Warrenton, Virginia.

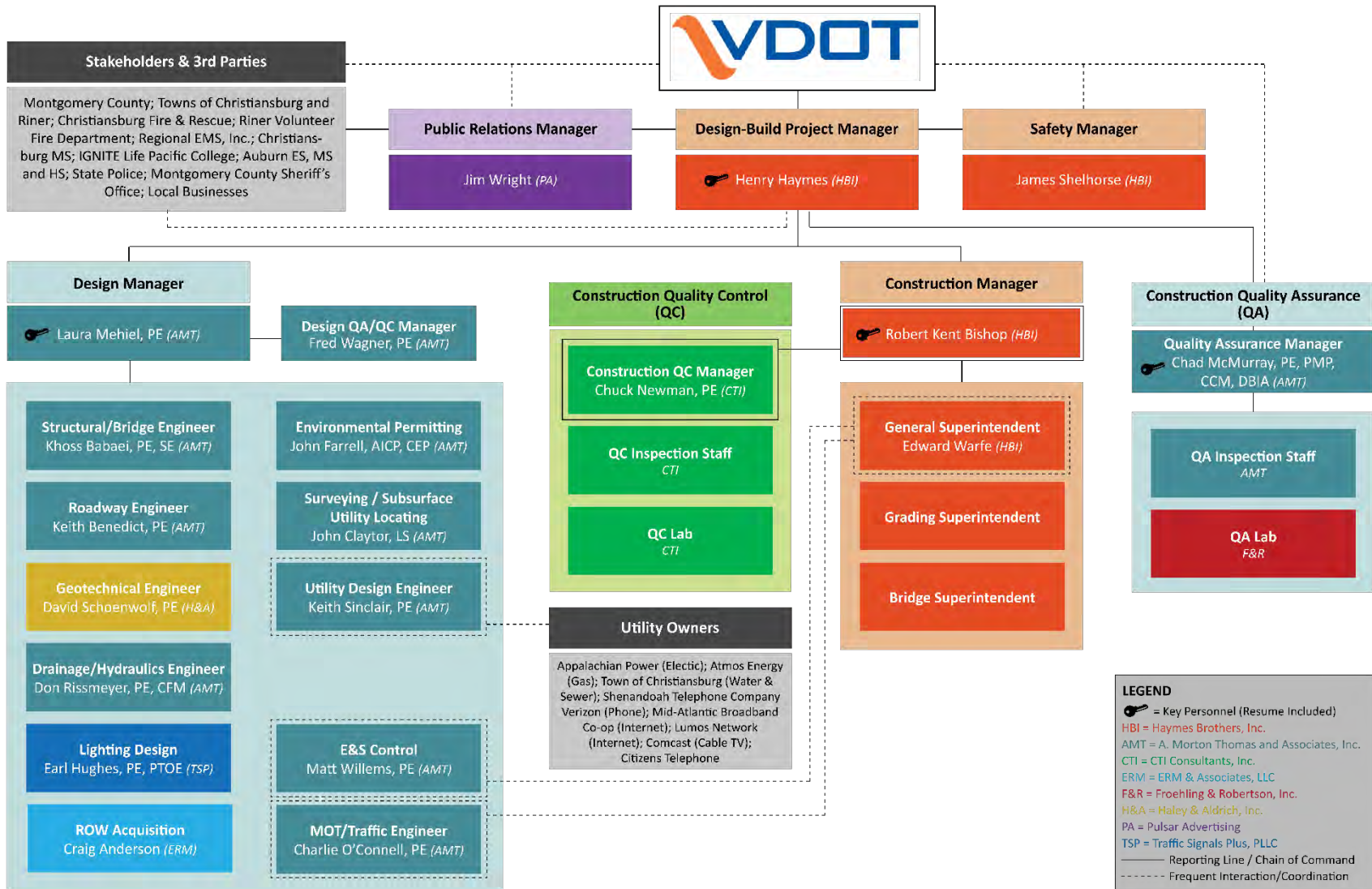

4.3 Design Concepts

Section 4.3: DESIGN CONCEPT

4.3 Design Concept Strategy

The Haymes Brother's Team design concept was carefully developed to meet all requirements listed in the RFP, and to exceed the requirements and project goals where feasible. The main factors that influenced our design strategy were:

1. reducing the overall duration of construction,
2. using common sense engineering to facilitate simple expansion/future construction projects planned for the interchange area, and
3. maximizing safety for both traveling public and workers.

The Volume II Concept Plan drawings depict our team's conceptual design, which will be used as the basis for final design. Various optimizations have been incorporated into our concept, as presented in the summary below. Our Technical Proposal design meets the roadway inventory information and major roadway design criteria identified in the *Design Criteria Table* included in the RFP Technical Requirements (Part 2), Attachment 2.2. Furthermore, our proposal concept limits of construction (including all stormwater management facilities) are within the existing or proposed right-of-way limits shown in the RFP Conceptual Plans. With the exception of optional improvements to Route 8 beyond RFP requirements, (see section 4.3.1.d), our concept does not require design exceptions or design waivers aside from those included in the RFP.

4.3.1 Conceptual Roadway Plan

The I-81 Exit 114 roadway design generally consists of revising the geometry of I-81, both horizontally and vertically, to replace the interstate bridges with minimal impact to traffic, while also eliminating substandard vertical clearance under the bridges. The project will provide improved shoulder widths, and will incorporate safety and functional measures including traffic barriers, and new signals at the ramp intersections. Improvements to I-81, Route 8, and the ramps will be designed in accordance with the Design Criteria of the RFP (RFP Attachment 2.2). The interstate will be designed in accordance with VDOT standard for a GS-1 (Rural Principal Arterial) facility in rolling terrain. Route 8 will follow GS-5 within the town limits, and GS-2 beyond the town limits, and the ramps will follow GS-R. The design speed is 70 MPH minimum for I-81 SB, 75 MPH for I-81 NB, 35 MPH for the ramps, 40 MPH on Route 8 in the town limits, and 50 MPH on Route 8 outside of the town. The two VDOT-approved design waivers provided with the RFP, for reduced shoulder width and design speed matching posted speed, are incorporated into our design.

a. General Roadway Geometry

Our conceptual roadway plans are provided in Volume II. The plans depict our geometry including horizontal

Design Highlights

Exceeds Design Criteria

- ▶ Vertical clearance of 16'-9" under I-81, exceeding 16'-6" minimum requirement
- ▶ Conversion of existing traffic barrier section to full clear zone, for 1000 feet of I-81 SB (south of bridge)

Exceeds Project Scope

- ▶ Option to add a right turn taper from Route 8 NB to I-81 NB
- ▶ Option to reassign paved width of Ramp D to increase length of dual lanes
- ▶ Edge line rumble strips along I-81, on new or resurfaced shoulders

Reduces Construction Duration, Facilitates Positive Public Perception

- ▶ New bridges constructed in two phases, versus four phases in VDOT concept
- ▶ Prepare standardized repair details to be used for existing bridge repairs

Exceeds Safety and Operations Goals

- ▶ Location of traffic barrier under the bridge provides for increased clear zone (25' from travel lane vs. 10' in VDOT Concept)
- ▶ Conversion of existing traffic barrier section to clear zone as described in Exceeds Design Criteria above
- ▶ Options for Route 8 right turn and Ramp D dual lanes described in Exceeds Scope section above

Enhances Long-term Performance and Durability (reduced maintenance or inspection)

- ▶ No construction joints in bridge deck due to design alignments and phasing
- ▶ Concrete barrier versus W-beam along Route 8 under bridge
- ▶ Net reduction in W-beam length

Recognizes Criticality of Maintaining Existing Bridge during Construction

- ▶ Prepare standardized repair details to be used for existing bridge repairs
- ▶ Haymes Brothers has repaired dozens of interstate bridges in the Salem District, and understands the Departments expectations and repair methods

curve data and associated design speeds, number of lanes, and widths of lanes and shoulders. Horizontal alignment geometry and associated design speeds are described in further detail in [section b.](#) below, and number of lanes, widths of lanes and shoulders are described in [section d.](#) below.

b. Horizontal Alignments

I-81 & Ramps. Our horizontal alignments for I-81 NB and SB have been established to shift the entire SB lanes into the median, away from the existing SB bridge. This approach allows for construction of the new SB bridge without requiring partial deck demolition on the existing bridge. The re-alignment is accomplished using a curve radius of 14,500 feet for I-81 SB, allowing for a normal crown at a 70 MPH design speed as per VDOT Standard 803.42. While the horizontal curve extends across the bridge, the actual bridge will be constructed as with straight edges, with a width set 2” wider than the RFP bridge. This arrangement will allow the curved alignment to be accomplished using striping across the bridge, with variable width shoulders meeting the minimum shoulder width requirement (6’ left, 12’ right). A schematic is shown in Figure 4.3.1

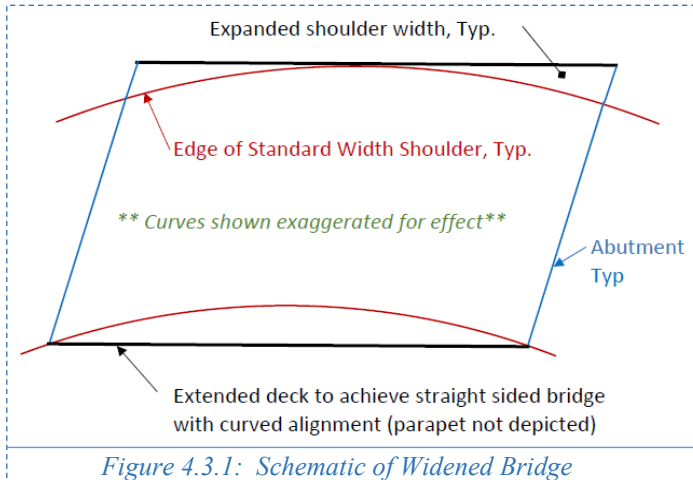

The NB I-81 alignment uses a tangent alignments with degree breaks of half a degree or less.

Route 8 and Ramps. The minimum Route 8 radius is 3,000 feet (matching existing), and the minimum ramp radius is 1,050 feet.

c. Maximum Grade for all Segments and Connectors

The maximum grade used in our concept design for all segments and connecting roadways is provided in the table at right. Roadway profiles are provided for I-81 only in Volume II.

Roadway	Proposed Max Grade %	Max Allowable Grade %
I-81 (SB/NB)	2.40 1.50	4 4
VA 8 (* **)	4.76 4.76	8 5
RAMP A	5.60	6
RAMP B	6.00	6
RAMP C	4.40	6
RAMP D	1.30	6

* Inside Town Limits | ** Outside Town Limits

d. Typical Sections (incl. ramps, retaining walls, & bridge)

The Haymes Brothers Team concept design typical sections, depicting overall roadway and shoulder widths, clear zones, retaining walls, traffic barriers, and other cross-sectional elements, are in Volume II.

Interstate. I-81 is designed to maintain two (2) lanes in each direction, each 12-feet wide, with open shoulders of a total width of up to 12-feet and varying paved width depending on location. Both total shoulder and paved shoulder widths are set utilizing Design Waiver No. 2, which generally uses a substandard overall shoulder width on the left side, while exceeding the minimum paved shoulder width on the left side. The interstate clear zone maintained is generally 30-feet from the edge of travel way, otherwise traffic barrier is provided. Milling, resurfacing, and pavement build-up will be applied to I-81 where shown on the plans.

I-81 Betterment: We propose to install edge line rumble strips along all portions of repaved I-81, as a betterment to the RFP scope.

Route 8. Route 8 typical sections include two (2) lanes in each direction within the interchange, transitioning to one (1) lane in each direction beyond the interchange, all generally matching existing conditions. Lane widths are 12-feet, or matching existing, and the shoulders are 10-feet wide, of which 8-feet will be paved. Milling and resurfacing will be applied to Route 8, as shown on the plans in Volume II. Under the bridges,

we will place pier protection BPPS-2, adjacent to abutments and extending along the wingwalls, in lieu of the guardrail shown in the VDOT concept.

Route 8 Betterment: With VDOT's concurrence of a design waiver for shoulder width, our team proposes to improve the movement between NB Route 8 and NB I-81 by adding a right turn taper, as shown on plan sheet 4 in Volume II. The concept is to reallocate the shoulder width to a right turn taper and short length of full width turn lane. A 2' width minimum paved shoulder would remain. This will improve the operation of the intersection, considering the heavy right turns that exist today and are projected to increase in the future.

Ramps. Ramp typical sections, as shown in Volume II, include one (1) lane that is 16-feet wide, with a 4-foot wide paved left shoulder, and an 8-foot wide paved right shoulder (increased to 10' where guard rail is present). Milling and resurfacing will be applied to ramps, as shown on the plans in Volume II.

Ramp D Betterment: With VDOT's concurrence, we propose to lengthen the distance of 2 full lanes on Ramp D approaching Route 8, by pushing the start of the lane addition taper back toward the gore.

Traffic Barrier. Traffic barrier locations are shown where clear zones cannot be met. In these locations, paved shoulders are generally increased 2 feet. This varies along I-81 as part of the design waiver.

Retaining Walls. There are two locations on I-81 in our concept design which require retaining walls:

STA 942+50 to STA 951+88, I-81 SB (median side)

STA 953+35 to STA 957+50, I-81 SB (median side)

Walls are proposed at these locations, as they were in the VDOT RFP concept, to address the bifurcation between SB and NB interstate lanes. Each of the walls connect to the bridge wingwalls. Based on our concept design, wall height is no more than seven-feet in these locations. Both walls are within the clear zone limits, and thus guard rail will be used adjacent to the shoulder in these areas. Additional information for the retaining wall design is provided in Section 4.3.2, Conceptual Structural Plan.

Bridge Structures. Bridge typical section drawings, reflecting two lanes at 12' width, a median shoulder at 6' width, and an exterior shoulder at 12' width for each bridge, are shown in Section 4.3.2.

e. Conceptual Stormwater Management and Hydraulic Design

Ditches, New Pipes & Storm Sewer Systems.

New surface drainage will be installed throughout cut and fill areas to properly convey flow from the travel lanes and shoulders via drainage ditches to storm drains and adequate outfalls. Roadside ditch linings will be designed to prevent erosion for a 2-year event using VDOT approved materials in accordance with VDOT EC-2 and EC-3 standards. Storm drain structures and pipes will be sized to collect and convey runoff to approved outfalls and potential stormwater treatment areas. The storm drain layout will be closely coordinated with other design elements, such as existing utilities, to minimize impacts.

Existing Pipe Rehabilitation/Replacement.

Ten existing drainage features have been identified for replacement or rehabilitation. Existing pipe culverts to be repaired will be rehabilitated in accordance with VDOT's guidelines outlined in *Chapter 8, Section 8.3.6.11 and 8.3.6.7 of VDOT's Drainage Manual and Special Provisions for Pipe Rehabilitation and Pipe Replacement*. Any features designated for replacement will be designed and constructed to convey the 25-year storm event with a maximum headwater to diameter ratio of 1.5. During design development, we will size and locate the drainage culverts to minimize disruption to the flow both upstream and downstream of the culvert. Replacements across ramps and I-81 will be built using jack and bore to minimize traffic impacts.

Stormwater Management.

This project is grandfathered under the Part IIC technical criteria in Section 9VAC25-870-93 et seq. of the VSMP Regulations, with our intention to place all erosion and sediment perimeter controls before June 2019.

Like VDOT, our team does not anticipate any post-construction SWM facilities will be required for the project. Nutrient credits will be sought as the first preference for any required quality control. However, if found to be needed during project design, SWM facility design will follow the VDOT BMP Design Manual of Practice, April 2013, and the latest VDOT IIM LD-195.

f. Proposed Right of Way Limits

The VDOT RFP Information package includes a proposed permanent drainage easement from the International Church of the Foursquare Gospel, totaling approximately 1699 square feet. Proposed right of way/permanent drainage easement limits shown in our Concept Design are the same limits defined within the RFP Concept Plans. All of our Team’s concept design is contained within the limits of the acquisitions defined by VDOT and as shown in our plans in Volume II. Our final design will also be contained within the proposed ROW/permanent drainage easements defined with the RFP Concept.

Our team notes that there were no utility easements defined in the VDOT conceptual design plans. Based on our review and initial coordination with the Utility Owners, we anticipate that no new utility easements will be required. Should they be required, however, we will include these easements on the ROW plans in accordance with VDOT requirements and procedures.

g. Proposed Utility Impacts

Numerous utilities exist within and adjacent to the project corridor, however most of them are beyond the limits of impact. Our design has considered potential impacts to utilities, and we have already coordinated with the utility companies to obtain as-built plans and information regarding utility relocations and timelines. Utility owners include:

- ▶ Appalachian Power
- ▶ Citizens Telephone Cooperative (Citizens)
- ▶ Shenandoah Telecommunications Company (Shentel)
- ▶ LUMOS Networks
- ▶ Town of Christiansburg
- ▶ Verizon Communications (Verizon)

The primary utility we expect to impact is the existing LUMOS Networks fiber line located along the Route 8 SB outside shoulder. The as-built drawings furnished by LUMOS indicates the location as 15 to 20 feet from edge of pavement, whereas VDOT’s utility file in the RFP shows it being a few feet from the edge of pavement. No matter the location, there is likely an impact either by pier demolition, or new abutment construction. Other conflicts may arise during the design, such as storm drain/fiber conflicts, or substandard clearance under the overhead line across I-81.

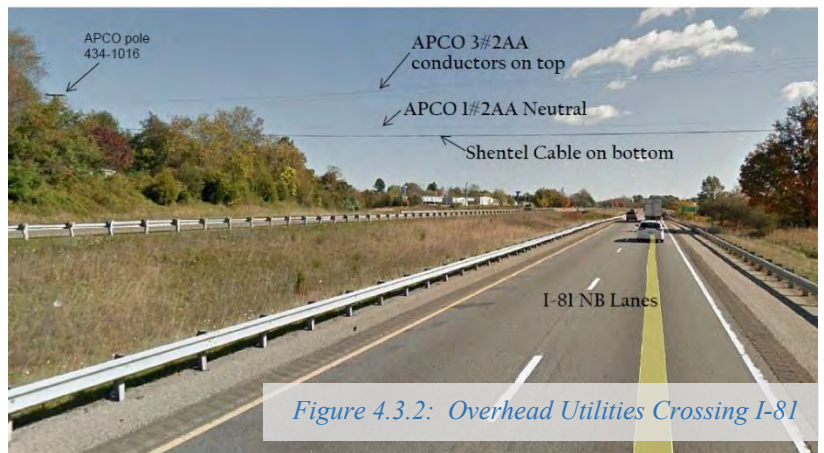

Figure 4.3.2: Overhead Utilities Crossing I-81

Minimizing Utility Impacts. Our team has assessed potential impacts and has a strategy to address those impacts, as summarized in the table below.

Utility Desc.	Approximate Location	Potential Conflict	Mitigation Strategy
LUMOS Fiber	Adjacent to Rte 8 SB shoulder	Pier demolition or new abutment construction	100’ slack at pull box per as-built; relocate line midway between ex. pier and new abutment
Shentel Cable OH	I-81 STA 948+50	<18.5’ min. clearance due to raising I-81 profile	If the clearance is insufficient, the line will have to be raised on taller poles, or placed UG
T/Tg Line	Rte 8 STA 1056+20, RT	Storm drain crossing	Impact unlikely based on location of existing storm drain
LUMOS Fiber	Rte 8 STA 1061+70, LT	Storm drain manhole	Avoid impact by shifting MH back to shoulder

During final design, concurrent with the conflict evaluation of each utility, we will investigate design changes to minimize or eliminate the impacts. When utility relocations are unavoidable we will work closely with the utility owner keep the project on schedule – see Section 4.4 Project Approach – Utilities.

h. Other Key Elements

Traffic Signals.

Our plan is to install the new traffic signals by October 2018, at the existing unsignalized intersections of Route 8 and the I-81 diamond interchange ramps, to reduce queuing during the construction period, and following the completion of the project. It is not anticipated that pedestrian ramps, pedestrian signals or crosswalks will be required at either intersection given the lack of existing and proposed accommodations along the corridor. The design, however, can be carried out so as not to preclude the installation of pedestrian features should they be incorporated as part of a future project. The following describes some of the key elements of the design concepts established for the installation of temporary traffic signalization:

NOTE: The DB Team will coordinate with all impacted existing utility owners to ensure adequate clearance for the span wire, signal poles and conduit.

- ▶ Intersection timing and phasing to be determined based upon a Synchro evaluation using existing traffic volumes for the signalized intersections at Route 8 at I-81 NB Ramps, Route 8 at I-81 SB Ramps and Route 8 at College Street. Queuing analyses will be performed to ensure adequate vehicle storage along the approaches.
- ▶ Traffic signals will utilize wood poles and span wire:
 - NB Ramps- Poles should be located on the NW and SE quadrants to avoid existing drainage features and improve sight-distance for the NB off-ramp right turn on traffic (RTOR) movement.
 - SB Ramps- Poles should be located on the NE and SW quadrants to avoid the perpendicular crossing of the overhead power lines and improve sight-distance for the SB off-ramp RTOR movement.
- ▶ The right-turning movement from Route 8 to the I-81 NB on-ramp will be modified/improved to facilitate vehicle access following the installation of the WB stop bar.
- ▶ The existing median will be modified at both intersections to accommodate the through movement from off-ramp to on-ramp, which we believe will be well received by Police/Fire and Rescue.
- ▶ Power will be provided by Appalachian Power via the overhead lines located on the east and west side of the interchange.
- ▶ The signals will include emergency preemption, communication to the SW Region Traffic Operations Center (TOC) and advanced queue detectors along the I-81 off-ramps.

Lighting.

Within the project limits under current conditions, roadway lighting will not exist along Route 8, under the I-81 bridge or at the Route 8 / I-81 ramp intersections. The project will install LED (Light Emitting Diode) luminaires in these areas on the aforementioned temporary wooden signal poles, on additional supplemental poles (installed if necessary) and on the new bridge abutments.

We will prepare a lighting analysis using Version 18 of the *Lighting Analysts* AGi32 software to determine photometrics, to achieve lighting levels in accordance with the recommendations outlined in *National Standard Practice for Roadway Lighting* ANSI/IESNA RP-08-14 in order to enhance safety along Route 8, achieving minimum roadway (1.8 foot-candles) and intersection (2.2 foot-candles) illumination levels.

A Roadway Lighting Plan will be prepared by the Haymes Brothers Team in accordance with VDOT's *Traffic Engineering Design Manual*. Power will be provided by Appalachian Power via the overhead lines located on the east and west side of the interchange. The Team will coordinate with existing utility owners to ensure adequate clearance for electrical conduit, junction boxes and appurtenances.

4.3.2 Conceptual Structural Plans

The Haymes Brothers Team's bridge concept meets or exceeds all requirements listed in the RFP, as summarized in the tables on the following pages.

VDOT REQUIREMENT	HAYMES BROTHERS DESIGN
<p>Design. <i>Design shall be per AASHTO LRFD Code, 7th Edition and VDOT Modifications (IIM-S&B-80.4), as well as the additional Foundation Criteria.</i></p>	<p>✓ Submit the plans in accordance with IIM-S&B-19.10 as a Tier 2 Bridge Project, including Preliminary Plans and Report (Stage I) and Final Plans (Stage II).</p>
<p>Load Rating. <i>Load Ratings shall be per IIM-S&B-86.1, Load Rating and Posting of Structures, and AASHTO's Manual for Bridge Evaluation, 2nd Edition with Interim Revisions.</i></p>	<p>✓ Structures will be load rated for all construction phases, carrying traffic in a temporary configuration, as well as the final, new structure, reflecting final traffic. Load rating will include the latest requirements of FAST Act vehicles EV-1 & EV-2.</p>
<p>Demolition & Erection. <i>Demolition & Erection plans shall be submitted to VDOT for approval prior to construction. Canopy protection will be designed by a PE in Virginia and installed for protection of all types traffic (motorist & bicycles) on Route 8 during demolition and construction.</i></p>	<p>✓ The demolition & erection submittal (within final plans) will provide general details for the proposed construction including, work site access, lane closures/ lane shifts, phasing, crane/ construction equipment placements, and protection shielding. We will determine the effect of equipment loads on existing bridge structures during demolition and erection and develop a procedure for using the equipment without exceeding the structure's capacity.</p>
<p>Bridge Size. <i>The minimum bridge width and length shall be per the bridge typical sections provided in the RFP Conceptual Plans. The northbound and southbound bridges will be separated by minimum 2-feet.</i> <i>The minimum vertical clearance over existing and future Route 8 will be 16'-6". The minimum vertical clearance of 16'-6" will be applicable to the future widening of I-81 by one lane and shoulder in each direction.</i> <i>The existing minimum vertical clearance will be maintained throughout the duration of the construction.</i></p>	<p>✓ Each bridge will have two 12' traffic lanes with a minimum 12' exterior shoulder and minimum 6' interior shoulder. The distance between the face of the parapets will be 42'-3". The out-to-out bridge width will be 46'-1". The vertical clearance will be based on future widening by one lane and shoulder. This will require adding 18' to each bridge in the future, with 12' shoulders wide shoulders in all locations, per VDOT Manual of Structures & Bridge Division, File 06.02.1. The minimum vertical clearance of 16'-6" will be maintained for the future widening over the existing Route 8 (including shoulders) as well as the future Route 8. The future VA Route 8 typical section is accounted for in the structural obstruction zone.</p>
<p>Superstructure Type. <i>The bridge shall be a jointless, single span bridge with a semi-integral backwall. It will be a steel plate girder structure with a composite concrete deck. Parapets will be VDOT 3'-6" high, F-Shape, TL-5 rated.</i></p>	<p>✓ Uncoated weathering steel, ASTM A709, Grade 50 ksi, will be used in the girders. The number of bolted field splices will be limited to two (2). Girder erection will comply with the VDOT SP for "Stability Requirements for Superstructure Erection". All bearings will be "Laminated Elastomeric Pad for Steel Girders", following VDOT standards. Bridge deck slab concrete will be Low Shrinkage Class A4 Modified. Corrosion Resistant Reinforcing Steel (CRR), per IIM-SB-81.7, will be utilized in the entire deck and in the railings. CRR will also be utilized in the jointless abutment backwalls and reinforcing steel, extending from approach slabs and retaining walls into parapets.</p>

Substructure Type.

The abutments of the single span bridge will be cantilever abutment walls with semi-integral backwalls. Steel H pile foundation will be used.

Concrete wingwalls will be extended from the abutment stem parallel to Route 8 and founded on piles.

The abutment walls, including the foundation pile cap, shall be located such to avoid the "Structural Obstruction Zone" (SOZ). Abutment battered piles may encroach into the SOZ only at a depth of 7' or greater based on the intersection of the vertical projection from point of encroachment and the horizontal projection from the existing Route 8 edge of pavement.

Substructure Collision Protection.

The abutments units shall meet crash load guidelines of the AASHTO LRFD as well as the standards in the VDOT Manual of Structures and Bridge Division.

Bridge Deck Drainage

Adequate bridge deck drainage shall be provided. The drainage analysis will be in accordance with FHWA Publication HEC-21, as well as VDOT and AASHTO requirements, such that the design storm drainage spread will not encroach into the travel lanes.

Architectural Treatment.

Architectural treatment will meet the criteria outlined in the VDOT Manual of Structures & Bridge Division, Part 2, Chapter 5.

Architectural treatment will be applied to the northbound and southbound bridges on: 1) both faces of the bridge parapets and terminal walls, 2) presented face of abutments, wingwalls, and associated retaining walls.

Utilities.

The bridges will have lighting installed under the bridges and conduits across the bridge as required.

Approach Slabs.

Structural approach slabs with sleeper pads shall be installed at each end of the bridge, conforming to the requirement of the VDOT Standards.

- ✓ Areas on the abutment around bearing seats will be designed to permit jacking and replacement of bearings.

All areas on the substructure (Abutments and wingwalls) will receive waterproofing coating in accordance with the SP for Waterproofing Coating. The coated areas will be the exposed faces from the top of the substructure (abutment seats, or top of wingwall), to the existing grade.

- ✓ VDOT Standard BPPS-2 barrier protection (ground-mounted, 54"- high) will be installed in front of the abutment stem and wingwalls along Route 8, beyond the "Structural Obstruction Zone". Future improvement to Route 8 may necessitate minor raising or lowering of the barrier, which can be accomplished easily without compromising the bridge abutments.

- ✓ Our concept requires deck drainage only on the NB bridge median shoulder, to limit spread from extending to the travel lane. The determination is based on a 10 year storm intensity of 5.97 inches/hour, derived from the B, D and E values from VDOT Drainage Manual Appendix 6-C at the closest NOAA-14 station, Pilot 1 ENE. Our preliminary plan is to drain into the drainage system adjacent to the NB shoulder south of the bridge, where we call for slot inlets in the shoulder along the MB-8 traffic barrier.

The deck drainage system hardware will conform to the requirements of the VDOT Road and Bridge Specifications, Section 226. The hardware will be galvanized steel with 8" diameter pipes, with cleanouts as required to reduce maintenance of clogs. Pipes and necessary downspouts will be pitched at 4% minimum, and hidden to the extent possible.

- ✓ Architectural treatment will be a drystack stone pattern matching that of the Renva W. Knowles Bridge for the Huckleberry Trail crossing of Route 114. Individual stone lengths will vary randomly from 3" to 24", a continuous-course stone pattern.

The individual stones will be randomly stained SAE AMS-STD-595 colors 10324, 23617, 26306. Coping and flat surfaces will be stained SAE AMS-STD-595 color 23617.

- ✓ The bridges will be designed to support the following utilities: 1) Lighting under the bridge and 2) Four 4"-diameter conduits, contained in one or more duct banks, across the bridge. The duct bank(s) will be located within the end bay on the right shoulder of each bridge. The utility support design will follow the VDOT Manual of S&B Division, including their structural supports and/or hangers.

- ✓ Approach slabs and sleeper pads will be installed in conformance with VDOT Manual of Structures & Bridge Division, Part 2, File 19.103-1, for transferring the thermal movements of the superstructure to the neoprene seal installed on the sleeper pad.

Our team's bridge design concept plans are provided in Volume II, and described further in the section below.

a. Existing Bridges

Existing Structure.

The existing I-81 bridge structures over Rte. 8 are both three (3) simple spans (53'-92'-53'). The superstructures consist of W36 rolled steel beams (spans 1 & 3) and steel plate girders each with a 48" web (span 2) and concrete decks. The substructure consists of multi-column concrete piers and stub abutments, supported on steel H-pile foundations.

Existing Bridge Geometry.

The existing northbound and southbound bridges are both 198' long and 30' wide curb-to-curb, 35' wide out-to-out. The piers and abutments are skewed at approximately 25 degrees. The horizontal and vertical alignment of both bridges is tangent. The grade is 1.40% and 1.20% for northbound and southbound bridge, respectively. The current existing minimum vertical clearance over Route 8 is 14'-11".



b. Repair Design Approach for Existing Bridges

The objective of the Haymes Brothers Team will be to maintain the existing bridges, to assure they will be functional to traffic at all times during construction. The existing bridges were built in 1964 and have reached the end of their service life. The most recent VDOT inspection has given them a rating of 4 out of 9 for the deck and superstructure, which means minimum tolerable condition to be left in place. Particularly, the bridge decks are in very poor condition with a significant amount of spalled/patched concrete, as shown in Exhibit 1. The continued spalling of the bridge decks is expected during the construction period. We will make sure the bridge elements, including the deck, joints, drains, parapets, guardrails, beams, bearings, and substructure are functional and safe for the travelling public on both I-81 and Route 8 throughout the life of the project.

Haymes Brothers has repaired these and other bridges along the I-81 corridor in the past and we know the challenges associated with safely and productively repairing the decks and other bridge elements while in service.

Given the significant traffic volume along this section of the I-81 corridor, our Team understands the need to minimize maintenance restrictions to the travelling public. Early on, our Team will proactively create procedures based on VDOT repair specifications to readily address the most common defects expected from these bridges during construction, based on their condition. We will submit the standard bridge repair procedures for VDOT's review and approval within 30 days, or less, of the beginning of the project.

In addition, to mitigate/eliminate the risk of impact on I-81 traffic flow from the continued deterioration of the existing bridges, our team will implement a periodic and systematic inspection schedule to monitor the condition of the bridges, before it gets to the point that deterioration interrupts the traffic flow. This proactive effort will allow repairing the bridges during nighttime or low traffic periods, to minimize traffic interruptions. Accordingly, we will submit to VDOT the specifics of this inspection for review and approval within 30 days, or less, of the beginning of the project. Haymes Brothers commits to providing an experienced emergency deck repair crew available anytime during the construction.

c. Proposed Bridges

Geometry.

The proposed northbound and southbound bridges are each approximately 146' long (bearing to bearing) and a minimum of 42' wide, face-to-face of parapets. The out-to-out width of the NB bridge is 45'-10", and of the SB bridge is 46'-0", including 3" architectural treatment built on the faces of each 1'-11" wide F-Shape parapet. The southbound bridge is 2" wider than the bridge shown in the RFP concept plans, to accommodate the curved roadway horizontal alignment while keeping the bridge a constant width. All abutments are skewed at approximately 25 degrees. The vertical alignment is a hump curve with grades of 1.30% & 0.65% for the northbound bridge and 0.98% & 1.31% for the southbound bridge. On the transverse section, both bridges are cross-sloped in the direction of Route 8 grade, to maximize space for the vertical clearance. The minimum vertical clearance over Route 8 is 16'-6", considering the future widening of I-81 and future cross section of Route 8.

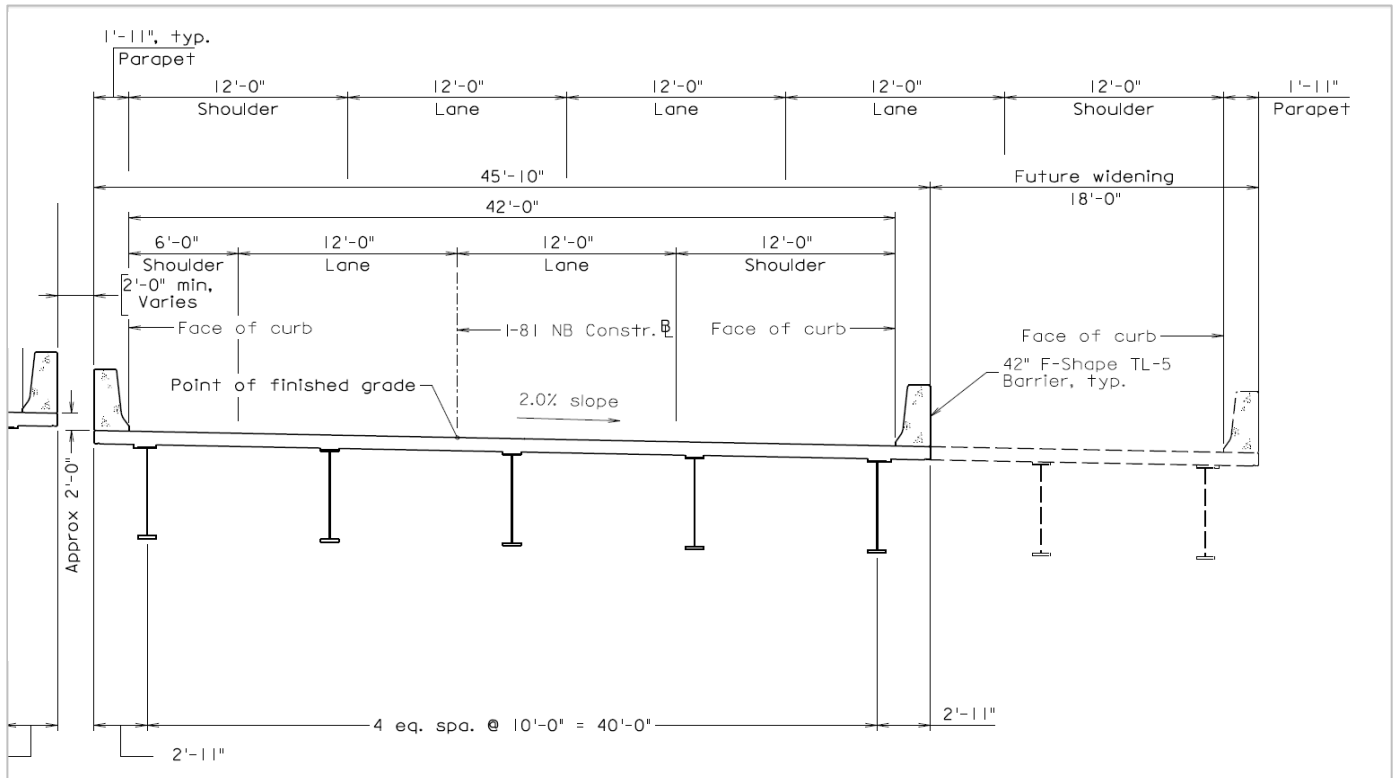

Transverse Section of Proposed Bridges w/ Future Widening (Half Section)

Construction Sequence of Proposed Bridges.

Recognizing that the work will be along one of the most heavily traveled interstate systems in the region, the Haymes Brothers Team has developed our design concept to reduce the number of construction phases and corresponding traffic shifts. The Haymes Brothers Team intends to perform the bridge replacement construction in two phases, by re-aligning I-81 southbound so that the new SB bridge is completely contained within the existing median. The sequence is described in further detail in Section 4.5.1.

The 2-phase construction of our design is an improvement to the VDOT RFP Concept.

Superstructure.

The northbound and southbound bridges will be built adjacently and separated by 2' minimum. The southbound bridge will be approximately 2' higher than the northbound bridge. The bridges will be single span, approximately 146' long between the centerline

of bearings. The superstructures will consist of steel plate girders each with a 60” web and 8 ½” thick concrete decks. The girders will be uncoated weathering structural steel. The barriers on the bridge will be 42” F-Shape parapets.

The girders will be embedded in semi-integral, jointless backwalls. Approach slabs, connected to the backwall and seated on sleeper pads, will transfer the thermal movements of the superstructure to a joint installed on the sleeper pads.

Substructure.

The substructure will consist of semi-integral, cantilever abutments founded on steel H-piles. The abutment stem wall will be continuous between the bridges, eliminating the need for the interior wingwalls for the adjacent, parallel bridges. The exterior wingwalls will be concrete and extend from the abutment stem parallel to the direction of Route 8 and founded on piles. The continuous abutment stem and the parallel wingwalls will be protected against collision along Route 8 via standard 42” ground mounted barrier protection.

The gap between the backwalls of the adjacent bridges (2’ min.) will be closed with a concrete wall, which will extend from the backwall of the southbound bridge (higher bridge) and be low enough to match the bottom of northbound bridge backwall. This wall will retain the median approach fill behind it.

The interior F-Shape barriers of the adjacent bridges will continue from the bridge decks onto the approach slabs. The barrier on the northbound approach slab (lower slab) will retain the fill from the southbound approach. Past the approach slabs, standard ground-mounted barrier (42”- high) will be installed in place of the interior F-Shape barriers, which will retain the fill along the two bridge approaches.

The exterior F-Shape parapets of the adjacent bridges will terminate on the deck with a standard terminal wall. The approach guardrails will be attached to the terminal walls on the decks.

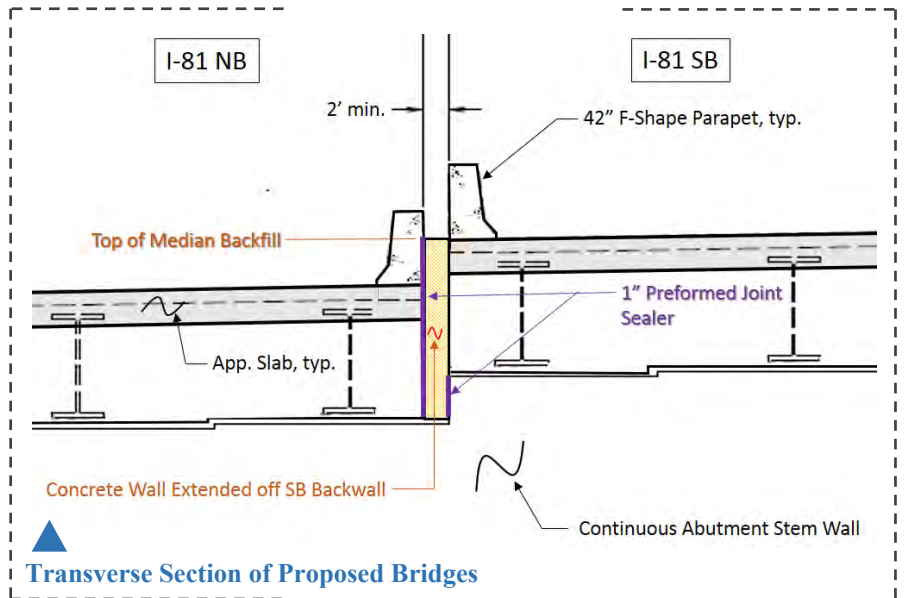

Transverse Section of Proposed Bridges

d. Proposed Retaining Walls.

There will be a retaining wall located in the median on both north and south approaches to the adjacent bridges, with a max height of 7’, and generally 3’ to 5’ high. Our Team may use a modified MB-8A barrier, a concrete gravity wall (RW-3), or concrete cantilever wall for these locations. Regardless of its type, the retaining wall will be designed in accordance with VDOT and AASHTO LRFD specifications for all applicable loads. The retaining wall will have a 42”, F-Shape concrete barrier on top facing the higher roadway approach. The wall will be designed for collision force on the barrier. Alternatively, the design may include a moment slab integrated with the barrier, in order to isolate the wall from the barrier and collision forces. The design will be submitted to VDOT for approval prior to the construction of the wall and barrier.

e. Major Drainage Structures.

Our team does not anticipate any major drainage structures (greater than 36” diameter).

4.4 Project Approach

4.4 PROJECT APPROACH

The Haymes Brothers Team has developed a comprehensive approach for managing the project through design and construction. The following pages provide an in-depth description of four (4) key elements which are often the predominant areas of risk management for design/build transportation projects:

ENVIRONMENTAL MANAGEMENT. This includes planned efforts during design and construction to avoid and minimize impacts to environmental resources. In addition, we describe our approach and potential solutions for addressing environmental conditions and areas of concern within the Project footprint.

UTILITY COORDINATION, ADJUSTMENTS, AND RELOCATIONS. We have identified which utilities we believe to be in conflict with the design, as well as potential solutions for accommodating those utilities. We also discuss mitigation strategies to offset the potential impacts of utility relocations exceeding estimated timeframes, or unidentified/non-located utilities being discovered during construction.

GEOTECHNICAL. Identifying and mitigating risks, including those related to Karst topography through knowledgeable application of geotechnical design and analysis practices and construction methods; and

QUALITY ASSURANCE AND QUALITY CONTROL. During both design and construction, including our staffing plan to meet the QA/QC requirements for the Project. Specifically, we address the QA/QC procedures for a unique Project element from each the design perspective and the construction perspective, which our team deems most critical.

4.4.1 Environmental Management

The Haymes Brothers Team is committed to the successful Project completion in a manner that avoids and/or minimizes impacts to the environment, ensures full compliance with applicable laws, regulations, and contract requirements, and honors VDOT's Project environmental commitments. **The Haymes Brothers Team's overall approach to environmental risk management is 100% compliance following a detailed avoidance, minimization, and mitigation process.** This process is built upon a foundation of accurate resource identification and thorough understanding of the rules and regulations protecting each resource. Early resource identification/confirmation and Rare, Threatened and Endangered Species (RTE) coordination will ensure we are aware of all the environmental design issues, and inclusion of realistic permitting timeframes and Time-of Year (TOY) restrictions in the schedule will substantially reduce the possibility of delays.

Environmental Highlights

Effective Environmental Risk Management to Mitigate Potential Delays

- ▶ No permanent impacts to wetlands or streams
- ▶ Integrated Design Team includes Permit Manager, who will review all design packages.
- ▶ No grading in I-81 median south of crossover, creating larger buffer to fuel spill area.

a. Environmental Management Plan

Our team's Environmental Management Plan defines environmental management roles/responsibilities, resources and mitigation strategies, and compliance documentation, developed from a thorough understanding of applicable federal, state, and local agency regulations. Our environmental team, listed in Table 4-4.1, brings a wealth of design-build and design-bid-build experience working on past projects for VDOT, including many in the Salem District. We will use this knowledge and experience to ensure compliance with applicable laws and regulations affecting this Project. We will implement the following strategies in our plan to guide Project environmental decisions:

- ▶ Accurately identify and designate environmental resources that occur within the Project limits;

- ▶ Apply our thorough understanding of applicable federal, state, and local agency regulations to avoid, minimize, and mitigate environmental impacts to the greatest extent practicable;
- ▶ Incorporate project environmental commitments into design processes, plans preparation, preconstruction planning, and construction activities;
- ▶ Maintain an environmental compliance program, including standards, procedures and audits, by conducting staff education, site inspections, and clear record keeping; and
- ▶ Construct the project in an environmentally responsible manner.

Table 4-4.1 Environmental Team Roles & Responsibilities

<p>Design-Build Project Manager (DBPM) » HENRY HAYMES</p> <ul style="list-style-type: none"> ✔ Working with EM, ensures that the design incorporates all regulatory requirements / commitments. 	<ul style="list-style-type: none"> ✔ Ensures environmental commitments/requirements are part of the “approved for construction” plans.
<p>Design Manager (DM) » LAURA MEHTEL</p> <ul style="list-style-type: none"> ✔ Ensures project compliance with laws and regulations, permits, contact requirements, and “approved for construction” plan and specifications. 	<ul style="list-style-type: none"> ✔ Ensures adequate allocation of staff to meet environmental commitments.
<p>Permitting Lead » JOHN FARRELL</p> <ul style="list-style-type: none"> ✔ Manages water quality permitting efforts, WOUS delineations, T&E species studies and clearances, avoidance and minimization efforts, agency coordination, and compensatory mitigation compliance. 	<ul style="list-style-type: none"> ✔ Facilitates coordination with regulatory agencies ✔ Provides QA assurance for water quality permit application and oversight for permit field inspections.
<p>Environmental Manager (EM) » EDWARD WARFE</p> <ul style="list-style-type: none"> ✔ Tracks environmental commitments through design and construction, performs QA reviews on “approved for construction” plans, and coordinates with the environmental team throughout the project. 	<ul style="list-style-type: none"> ✔ Working with the CM, facilitates the proper installation and maintenance of all field implementation of the “approved for construction” plan.

The Haymes Brothers Team has reviewed the NEPA documentation and supporting technical studies for the project, followed by a site review for a full understanding of the environmental commitments to design and construct this project as outlined by the environmental documents and current regulations. Table 4-4.2 summarizes the identified environmental issues.

Our Team will use an environmental commitments database, perform periodic monitoring of the project to assess and document performance, and confirm that the environmental compliance commitment requirements are met. Commitment compliance will be achieved through regular communication between the Environmental Manager and roadway and utility design engineers.

Element/ Project Limits	Level of Impact
Cultural Resources	○
Threatened/Endangered Species	○
Wetlands/Waters of the U.S.	○
Air Quality	○
Noise	○
Hazardous Materials	●

Legend: ○ No Significant Impact ● Minor Impact
 ● Potential Impact ● Moderate Impact

Environmental Resources.

Wetlands. It is understood that VDOT has performed a preliminary wetland delineation and the successful team is responsible for performing a final delineation of wetlands, as well as coordinating and submitting a Jurisdictional Determination Request (JDR) to the USACoE. Based on the preliminary information provided in the RFP package, seven wetlands exist in the general project vicinity, however only one of those wetlands, W-1, will be impacted by the project. The impact will be temporary, due to pipe abandonments at two locations, thus it is very likely that mitigation will not be required.

Our team’s approach to wetlands delineations (concurrent with streams) is to initiate the determination and permitting process as soon as possible. It is of critical importance that the regulatory review starts very early in the design process. Recent project experience with the USACoE in the area indicates that review and permit issuance time frames are prone to extend, based upon limited USACoE personnel resources and availability. Providing as much time as possible for review will eliminate the potential for schedule impacts.

Wetland 2

This wetland area is likely considered to be an Isolated Wetland of Minimal Ecological Value (IWMEV), due to poor plant diversity, lack of connectivity to jurisdictional waters and location within the median of I-81. Given the status of this resource, mitigation is not required and avoidance, while preferable is not pertinent.

Wetlands 1 & 6

The relatively isolated nature of wetlands W-1 and W-6 and lack of connectivity to potentially jurisdictional waters of the US may qualify this feature to be in the same category as W-2 (IWMEV). A confirmation meeting with the COE will be required. Recent jurisdictional determinations and USACoE actions in Christiansburg support this potentiality.

Wetlands 3, 4, 5 & 7

These Palustrine Emergent Wetlands (PEM) are directly associated with adjacent potentially jurisdictional streams. PEM wetlands require mitigation at a ratio of 1:1, the least expensive of the three common wetland types to mitigate.

Streams. As with wetlands, streams within the project area will require classification and a jurisdictional determination. It is expected the USACoE will claim jurisdiction over streams J-1 thru J-5, however impacts are not anticipated to any of these waters. Should this condition change during design, a JDR will be sent to the USACoE for concurrence, and a Unified Stream Methodology (USM) analysis will be conducted to determine the number of stream credits required for mitigation.

Permit Application. Upon receipt of a jurisdictional confirmation and a limits of disturbance from the design team, a Joint Permit Application (JPA) will be submitted to the Virginia Marine Resources Commission (VMRC), who will route the permit application to the USACoE and DEQ for review and comment, and ultimately issue a State Programmatic General Permit (SPGP) from USACoE, and a VWP General Permit No. WP3 from DEQ

Compensatory Mitigation. The Haymes Brothers Team has evaluated possible mitigation opportunities within HUC 030101010104. Wetland Mitigation banks within the HUC are generally lacking in sufficient credits to sell. Though not anticipated, if permanent wetland impacts are to occur requiring mitigation, after exhausting all options for purchasing mitigation credits from certified banks the team will coordinate with the VA DEQ and the USACoE for a payment to the In-Lieu Fee Fund. Though not anticipated, if permanent stream impacts are to occur requiring mitigation, we will use **The Graham and David Mitigation Bank**, which has stream credits in sufficient quantity to satisfy any mitigation needs of the project.

Threatened and Endangered Species and Migratory Birds. The Team understands that threatened and endangered species have the potential to be encountered during the construction of the project. Specifically, the endangered Indiana Bat, the threatened Northern Long Eared Bat and the endangered Roanoke Log Perch have been identified. Review of the provided information and desktop resources indicates that neither bat species is known to roost on the structure to be replaced or to summer roost in trees within the project area. As a component of the project environmental management, a physical review of the work area will be undertaken prior to the commencement of daily work to confirm that neither bat species has taken roost within trees or structures. Additionally, the Roanoke Log Perch is not known to inhabit the waters within the project limits. The nearest confirmed occurrence is approximately 10 miles from the project area. As with the identified bat species of concern, environmental management staff will review work limits near streams for the presence of the fish.

As with the potential presence of roosting bats, migratory song birds, specifically Swallows and Swifts may decide to take up residence in the bridge structure to be replaced. A thorough review for the presence of birds will take place prior to and during all phases of structure demolition. Should nesting birds be encountered, a USFWS certified Team member will be employed to safely remove and relocate the animals.

Environmental Conditions and Areas of Concern.

Soil Contamination. The Team has thoroughly reviewed the provided information as it pertains to hazardous materials within the project area. It is understood that a petroleum tanker accident and fire discharged a significant amount of petroleum products within the median of I-81 near the southern limit of project. Additional sites within close proximity to the project disturbance include the Flanagan Drive construction debris area (a potential environmental concern due to the presence of an unknown quantity and type of

construction debris in the area), two gas stations at 1404 Mud Pike, and the Deli Mart #22 at 1250 W. Main St., and a former warehouse and residence at 1330 Mud Pike. Soil disturbance is not anticipated in the proximity of any of these sites. Disturbance to the area of the fuel spill is also not expected based on our team's design. If changes in the design dictate the previously impacted area will be within the construction limits of disturbance, the contaminated soil limits will be determined and the soil removed and transported to an approved disposal facility.

Asbestos at Bridge. Approximately 20-square feet of caulking composed of Asbestos Containing Material (ACM) was discovered at both the northbound and southbound bridge rail post pad/sealed areas. The level of Chrysotile asbestos material within the sealant was determined to be approximately 10%, thus remediation is required per VDOT's Asbestos Project Monitoring and Clearance Air Monitoring Procedure. The construction environmental manager will be present as the bridge is being demolished and removed to ensure that any potential ACM is recognized and dealt with appropriately. Haymes Brothers will use a certified abatement firm for asbestos removal.

Efforts to Avoid/Minimize Impacts to Environmental Resources during Design Phase.

Avoidance and minimization are critical to conserving environmental resources. During the design phase of the project, the environmental management team on both the design and construction disciplines will review the project limits and objectives along with the means and methods proposed to build the job. When possible, permanent impacts will be avoided and minimized by limiting construction access and staging to areas outside of the environmental resource footprint. When impacts are unavoidable, they will be minimized to the greatest extent possible. Temporary impacts to environmental resources are often a component of transportation projects. The Team will employ measures to limit the extent of temporary impacts such as the use of heavy timber matting in wetlands and to cross streams. When topography, vegetation and hydrology are impacted temporarily the team will restore the impacts to pre-construction condition through careful grading and re-establishment of the vegetative community.

Environmental Permitting. Members of the Haymes Brothers Team have successfully secured environmental permits on numerous other VDOT transportation projects and has a complete understanding of the required documentation, evaluation, analysis, and coordination necessary to secure critical environmental permits as quickly as possible.

Environmental Team Meetings. During the design phase, the design engineers, construction personnel, environmental staff, as well as any other key staff necessary will participate in regular design and constructability reviews to analyze all environmentally sensitive areas within and adjacent to the project. This allows the Haymes Brothers Team to understand the actual impacts of the project and all requirements associated with those impacts to include schedule constraints as well as operational constraints. The sensitive areas adjacent to the project will be reviewed to ensure that impact to those areas is avoided and the proper controls are included in the design to control construction activities that may have an impact on those areas.

b. Construction Phase

After the plans are complete and approved, the construction team will take over the lead for avoidance, minimization, and mitigation. The design and environmental staff however, will be engaged for the duration of the project's construction. All preconstruction personnel will be engaged throughout the construction to assist in monitoring, mitigation and avoidance as necessary. During construction, all field efforts for avoidance and minimization will be led by Edward Warfe the Construction Environmental Manager. He will ensure that all environmental constraints are identified and protected throughout the project.

Prior to the beginning of construction in any area, all environmentally sensitive areas will be discussed with and identified for all field personnel. Prior to any field operation, all flagging of jurisdictional areas will be inspected and reflagged as necessary. Additional areas of concern and constraint will be identified in the field with a perimeter of safety fence; examples will include septic systems, areas of Time of Year

Restrictions (TOYR), etc. Ed will ensure that the team will continue to monitor and improve the plans based on actual field conditions to ensure that all avoidance measures implemented as outlined in the project plans and are modified based on field conditions as necessary. During the preconstruction meetings, field personnel will be made aware of the location of all known environmental resources that require protection. Haymes Brothers has years of experience working in environmentally sensitive areas with a successful track record. Our CM, Kent Bishop and the numerous Haymes Brothers foreman hold erosion control certifications.

At the initiation of construction, all ESC measures will be installed in accordance with the approved plans and all environmental monitoring will commence in accordance with applicable permits, standards, and specifications. Also, in addition to field implementation of plan measures for avoidance and treatment, these measures will be reviewed to ensure not only proper installation and maintenance, but also to identify additional measures that should be installed to guarantee avoidance, minimization, and mitigation. Ed will constantly monitor all operations for compliance with all requirements enhancing our team’s ability to avoid and minimize project impacts. At a minimum, the project will be reviewed weekly and after each weather event for environmental compliance.

c. Environmental Permit Scheduling

Reasonable anticipated timeframes to obtain required permits are reflected in our Proposal Schedule. The starting dates for each anticipated permit is also tied to the appropriate timeline in the development of the design plans, ensuring that enough detail for grading, drainage, temporary construction access, and utility relocations are available to ensure limits of permits are adequate for completion of the project. Our Baseline Project Schedule that will be submitted after award will include activities for all permit submittals, reviews, and approvals. It will also include activities for all mitigation necessary to be in compliance with permit requirements. The schedule will also include any agency reviews required that are not part of any permit. All work plan submissions, reviews, and approvals will be included in our Baseline Project Schedule, including a detailed all-inclusive list of activities required will allow us to track all environmental requirements to manage and minimize these risks throughout the project and identify when additional actions or adjustments will be needed to mitigate any potential delays to the overall completion of the project.

4.4.2 Utilities

Conflicts with existing utilities can create the potential to significantly impact the project schedule and cost. On Design-Build projects this risk is even greater for several reasons. At the RFP stage, the design is preliminary and it is not always feasible to determine the full extent of utility impacts. Furthermore, the design-builder has limited leverage to motivate the utility owners to complete their efforts within the project schedule. Our team’s experience managing this risk will allow us to effectively coordinate with both public and private utilities impacted by the project.

Utility Approach Highlights

Minimize Utility Impacts, and Mitigates Unexpected Conflicts

- ▶ Thorough review of potential conflicts in proposal phase, setting the stage for design
- ▶ Bridge construction not depending on any utility relocations
- ▶ AMT has in-house SUE staff who can mobilize quickly to ascertain utility data

To be properly prepared for the utility issues, our utility engineering staff has begun communication with each utility owner and developed our specific plan and strategy to address the utility work plan, schedule, and cost. The following represents our understanding of the relocation plans, nature of the work, our schedule, and the utility company requirements.

a. Utilities in Proximity, and Potential Conflicts with Design

The Haymes Brothers Team has performed in depth conflict analysis of all utilities in the corridor, as well as developed strategies to address the conflicts. Utility assessment summaries are shown below, and noted conflicts are further detailed in 4.3 Design Concepts.

Utilities in Proximity »

Appalachian Power / Shental Cable

- Existing overhead electric distribution line crosses both I-81 and Route 8. Currently working with Appalachian Power (AP) staff to verify if there is adequate existing vertical clearance to accommodate the new construction. AP has indicated the lowest line on the poles is Shental Cable. If adequate clearance does not exist, we will work closely with Appalachian Power staff to develop the most cost-effective manner to relocate the line. Options include jack and bore conduit under the interstate, or setting taller poles for overhead line.

Shenandoah Telecommunications Company (Shentel)

- Existing overhead lines are located on the same poles that carry the Appalachian Power lines that cross both I-81 and Route 8. Currently working with Shentel staff to verify if there is adequate existing vertical clearance to accommodate the new construction. If adequate clearance does not exist, we will work closely with Shentel staff to develop the most cost-effective manner to relocate the line.

LUMOS Networks

- Existing underground fiber optic line on the southbound side of Route 8 directly beneath the new bridges conflicts with the demolition of the piers for the existing bridges and/or the abutments for the new bridges. We will relocate to an area between the piers of the existing bridges that are to be demolished and the abutment for the new bridges.

Citizens Telephone Cooperative (Citizens)

- Existing underground fiber optic line on the southbound side of Route 8 directly beneath the new bridges appears to have sufficient separation from the bridge piers to be demolished that relocation is not anticipated to be required.

Town of Christiansburg

- Existing watermain crossing beneath I-81 at station 965+13± appears to have sufficient depth to avoid any impacts resulting from the new construction.

Verizon Communications (Verizon)

- Existing underground duct located on the northbound side of Route 8 is crossed by a new storm drain located at station 1056+22±. The new storm drain is replacing an existing storm drain that currently crosses the duct and will retain its' current alignment (both horizontal and vertical). Therefore, no anticipated impacts will result from the construction

Minimizing Utility Impacts.

Should issues arise during design resulting in new conflicts, we will look at design changes to minimize or eliminate the impact to the facility and coordinate with the roadway designer. When utility relocations are unavoidable we will work with the utility to minimize the length of the relocation and recommend alignments to avoid conflicts with the project and other utilities.

b. Coordination with Utility Owners

Utility Coordination Team.

The DB Utility Coordination Team, led by Utility Manager, Keith Sinclair, PE will be convened and meet regularly in the form of Utility Task force meetings. Through these meetings and monitoring of the design, potential impacts will be identified, to be shared with the utility owners. The need for additional utility locating, including test holes, will be initiated by the Team or in response to a request by a utility owner. The first effort will be to redesign, to avoid the utility if possible. Where not possible, the plans will be given to the utility companies as an update to the coordination which has already begun in the proposal phase, through early coordination meetings (pre-UFI).

In addition to coordination with existing utilities within the corridor, our team recognizes the potential for the Town of Christiansburg's long term water and wastewater project to coincide with this contract. Our team will coordinate with the Town as needed.

Early Utility Coordination Meetings.

The DB Utility Coordination Team will schedule early coordination meetings with each utility company to share project information including scope of work, sequence of construction and schedule milestones. At these meetings, we will inform the utilities that the project will be following relocation procedures of VDOT's Utility Manual regarding cost sharing and submittal requirements. We will review the preliminary scope of required relocations and will discuss permanent and temporary easement requirements, prior rights

agreements and any special conditions related to the relocation such as work methods, lead times for material and crews, permits, outage requirements and seasonal demands. Identification of the condition of the facilities will be discussed and the potential of having to replace sections encountered during construction of the project. We will also request any as-built information that may be available. The as-built information will be incorporated into the project design files as existing conditions.

The most current plans will be provided at the early coordination meetings and updated plans will be distributed as the design proceeds to the preliminary and intermediate design submittals. We will meet with the utilities as design progresses to review and discuss any special design elements or concerns. Plans from each submittal will be provided to the utilities for use in preparing their relocation plans.

Continued Utility Coordination - Prior Rights.

We will supplement our utility assessment with any additional information obtained from the early coordination meetings. Additional utility surveys, utility designation and test holes will be obtained, by the Design-Builder Survey Team, to identify and confirm potential conflicts. Using this evaluation, the cost sharing responsibility of any required utility relocations will be documented on VDOT form UT-9 and shared with each utility company. Each utility company will be requested to submit documentation confirming prior rights to substantiate the cost sharing percentage determined on the UT-9. The cost sharing percentage will be updated based on documentation received from each utility company supporting their prior rights.

Utility Agreements will be executed with all utility owners who will require relocations. For utility owners not impacted, we will obtain letters of no impact.

We will verify the prior rights of each utility owner's facilities if claimed by a utility owner. If there is a dispute over prior rights with a utility, Haymes Brothers will be responsible for resolving the dispute. We will prepare and submit to VDOT a Preliminary Utility Status Report within one hundred and twenty (120) days from the Date of Notice to Proceed that includes a listing of all utilities located within the Project Limits and a conflict evaluation and cost responsibility determination for each utility. This report will include copies of existing easements, As-Built plans or other supporting documentation that substantiates any compensable rights of the utility owner.

Continued Utility Coordination: UFI and Relocation Plans. Following the early coordination meetings, we will conduct a preliminary review meeting (VDOT Utility Field Inspection Meeting) with all utilities to review the overall project scope, milestones and utility relocation schedule and preliminary cost responsibility determination. We will continue to monitor the progress of each utility company, prepare a relocation plan and estimate to ensure they are meeting the schedule milestones and have the required project information needed to support their design.

We will obtain relocation plans including letters of no cost where the utility owner does not have a compensable right, utility agreements including cost estimates and relocation plans where the utility owner has a compensable right, or letters of no conflict where the utility owner's facilities will not be impacted by the Project.

Having met with VDOT's Regional Utilities Manager / Design-Build Projects Utility Coordinator within forty-five (45) days from the date of Notice to Proceed, we will confirm our full understanding of what is required with each P&E submittal. We will review the relocation plans and estimates prepared by the utility companies to ensure that all relocations comply with the current editions of the VDOT Utilities Manual of Instruction, Utility Relocation Policies and Procedures and the VDOT Land Use Permit Manual. Each relocation plan will be reviewed to ensure no conflict with the proposed roadway improvements and other utility owner's relocation plans. We will also review quantities and cost estimates and any adjustments to the UT-9 cost determination. All relocation plans will be assembled and submitted to VDOT in a manner that VDOT can approve the submittals with minimal review. Once approved, we will notify the utility company to proceed with relocations.

Relocations and Adjustments. All proposed utility relocations and adjustments will conform to the Haymes Brother's Utility Scope of Work as defined within Request for Proposal for the I-81 Bridge Replacement at

Exit 114. In addition, we will follow the guidelines provided in the VDOT Utilities Manual of Instructions (Tenth Edition, Published 1/1/2011, or as amended) to establish the general framework for addressing the utility issues, responsibilities, terms and conditions under which the work (relocations and adjustments) will be performed within the Project affecting each Utility Owner.

Betterment. Should a relocation of the Shentel Cable and/or Appalachian Power overhead lines be required across I-81, and should undergrounding be selected, this would be considered a betterment. The cost of the betterment would be assigned 100% to the utility owner, regardless of prior rights.

Mitigation Strategies to Offset Impacts of Utility Relocations Exceeding Timeframes or Unidentified/Non-Located Utilities Being Discovered During Construction.

We have multiple strategies to mitigate impacts of delays associated with utility relocations going beyond schedule timeframes, and discovery of unknown utilities.

Mitigate Utility Relocations Exceeding Timeframes.

- › Utility Task Force to monitor and push the process
- › Members of our Team who can design overhead pole lines and gas distribution
- › Utility Tracking Matrix updated weekly and reviewed by Project Manager (design & construction)
- › Effective UFI Meeting with the right attendees
- › In-Depth knowledge of VDOT Utility Manual, RUMS, and VDOT requirements for Utility P&E's
- › Schedule appropriate construction activities to be completed concurrently with utility relocations
- › Grade new areas while leaving existing poles in place, if needed

The key to safeguarding against potential schedule problems with the utility companies is consistent, ongoing communications. The Haymes Brothers Team will continually track and communicate with the companies involved throughout the entire relocation phase. Through our experience coordinating utility relocation projects, we have developed a tracking system that will be updated regularly and allow us to look ahead to prepare for the coming stages.

The relocation tracking begins at the UFI, setting the dates for the easement requests, P&E submissions, start of field work, and the target completion dates for each utility. As easement requests are completed, the needed parcels will be listed and tracked as they progress through the acquisition process, and the final documentation supplied to the utility(s) needing the easement when received. This allows us to quickly see how many parcels remain and keep close communications with the ROW staff for forecasts on closings to better allow the utilizes involved to start preparing to mobilize to the field and be ready to proceed at the earliest point in time.

As construction begins, Haymes Brothers field personnel will track the progress of the relocations as well as communications with the company field supervisors themselves. Progress meetings will be held with all utilities involved onsite on a bi-weekly basis. If it is apparent that a utility is falling behind, meetings will be held more often to partner in solutions to get back on track.

Mitigate Discovery of Unidentified/Non-Located Utilities. During the proposal phase, we have contacted every utility company we have identified to be within the corridor and confirmed that the RFP plans appear to list all the utilities that claim facilities in the corridor. However, if we should encounter an unidentified utility, we will bring in AMT's SUE group as well as Miss Utility to help track the line down to a point of identification (hand-hole, marker post etc.). Once identified, we will immediately contact the company to come to the field and verify it is theirs and if it is active or abandoned.

Lastly, our utility field staff, led by Mark Wiley has 40 years of experience, has a clear understanding in solving field issues and finding solutions to complicated problems. Their oversight of the utility relocations in the field will help foresee potential problems and greatly aid in overcoming any unforeseen problems.

4.4.3 Geotechnical

a. Geotechnical Approach

Our Team’s project approach to identifying and mitigating the geotechnical risks will be led by Haley & Aldrich, Inc. (H&A). Our approach is based on our experience and our understanding of project requirements set forth within the Chapter 3 of the VDOT, Material Division Manual of Instructions (MOI); the current AASHTO LRFD Bridge Design Specifications 7th Edition, 2014 and VDOT Modification’s; Section 400.04 of the VDOT 2016 Road and Bridge Specifications; and the minimum requirements in Section 2.6.4.2 of the RFP.

Once awarded the project, we will conduct a formal review of all provided and available relevant documents to assess existing geotechnical information to tailor our geotechnical exploration to confirm design elements, support alignment (vertical and horizontal) changes, and to address geotechnical issues relative to the final design.

We have identified that approximately 33 additional geotechnical boring and eight (8) pavement cores are necessary to provide sufficient subsurface data, and comply with Chapter 3 of VDOT’s MOI requirements and Section 2.6.4.2 of the RFP. The tables at right summarize our drilling and lab program.

b. Key Geotechnical Issues

The Haymes Brothers Team is keenly aware of the geotechnical issues associated with this project and proposed alignment. Review of existing project information indicates there are areas within the project limits that pose significant geotechnical challenges and risk that may have adverse impacts to quality and schedule. Those geotechnical risks include:

- ▶ Karst Geology resulting in cavities in rock and sinkholes
- ▶ Soft, compressible soil above the rock strata
- ▶ Widening of embankments, i.e. construction of “sliver fill” slopes

We have developed an approach to quantify and mitigate those risks during design and will be implemented during construction.

Karst Geology.

Bridge Foundations. Based on the Team’s experience, we know that the subsurface conditions of the New River Valley consist of carbonate bedrock and fault zones. Zones of this carbonate bedrock tend to dissolve creating solution cavities, sinkholes, rock shelves, and conduits for groundwater flows. The Geotechnical Data Report (GDR) prepared for the project indicates that the geologic conditions in the site vicinity consist of variable depth to bedrock. One of the bridge borings encountered a 14-ft. thick clay seam in the bedrock, which is common in this geology. At this time, it is expected that the bridges will be founded on steel H-piles driven to end bearing on rock. Test borings will be drilled for bridge foundation design in accordance with the MOI. Bedrock will be cored to identify voids and/or soil-filled seams in the rock. However, test borings will only identify the soil and rock conditions at the boring locations. To identify potential voids or soil-filled seams in the rock between borings at the bridge abutments, we plan to perform

Geotechnical Highlights

Recognizes Challenges Working in Vicinity of Existing Foundations, Maintaining Existing Structures, and Maintaining/Reconstructing Existing Slopes

- ▶ Electrical resistivity subsurface investigation to identify void zones in rock
- ▶ H-piles to prevent construction-related impacts on existing bridge by not causing soil heave
- ▶ Benching or geogrid to widen embankments

Borings / Corings

- 16 Roadway Alignments
- 8 Cores
- 0 Bridge
- 0 Storm Water Management
- 0 Culverts & Drainage
- 17 Retaining Wall Structures

Laboratory Testing

- 85 Moisture Contents Test
- 10 Atterberg Limits
- 6 Corrosion Test (pH & resistivity)
- 4 Culverts & Drainage
- 4 Retaining Wall Structures

a geophysical survey along the alignment of the abutments. An electrical resistivity survey will be performed that will characterize the soil and rock strata to a depth of approximately 100 ft.

Before the borings are drilled, an electrical resistivity survey will be performed. Water or soil filled voids and highly fractured rock are indicated by low resistance zones, whereas hard rock provides a signature of high resistance. Air filled voids also provide high resistance, but can be identified based on the surrounding soil response. The electrical resistivity survey provides a continuous profile with depth along its alignment and will identify zones in the rock that could be voids or cavities. The test boring locations can then be selected to drill at those locations to provide further geotechnical data about the extent and filling in the voids or cavities. That information can then be used to reduce the risks of the voids having a negative impact on the future performance of the bridge foundations.

We plan to perform a geophysical survey along the alignment of the abutments, to characterize the soil and rock strata to a depth of 100-feet. This will develop a continuous profile along its alignment and will identify zones in the rock that could be voids or cavities.

In situations where specific foundations are influenced by karst features, H&A would look at a few different approaches. One approach is utilizing H-piles with a steel drive point driven through the solution feature and into the sound bedrock. This approach was used for the design of the bridges at the adjacent I-81/Route 460 Interchange. In this case many low capacity steel H-Piles would be used to support a bridge abutment. (Note: As steel H-piles are non-displacement piles, installing them on this project will also help reduce the construction-related impacts on existing structures by not causing soil heave.) Another approach is to install drilled shafts socketed to a safe depth into rock below the karst feature; however, this alternative may not be suitable for the type of abutments (integral abutments) shown in the Team's design plans for this project.

Roadway and Retaining Wall Structures. Karst features have the potential to cause sudden and potential catastrophic failures such as the collapse of a section of roadway or retaining wall. Karst features introduce a significant risk to the project because they can remain dormant, shielded by soils or a thin layer of rock and be undetectable at the ground surface with the naked eye and even through conventional soil borings. Encountering an unknown karst feature during construction could introduce the need for design modifications that could impact traffic operations, construction budget and completion of the project on schedule.

To help reduce the risk of encountering karst features during construction, before the boring program is implemented, a review of historical topographic maps and/or aerial surveys will be performed to help identify areas where sink holes may be forming. Early in design, we will discuss previous maintenance issues with VDOT to assess the potential for sinkholes to form. An H&A geologist will visit the site to observe the existing surficial topographic conditions for evidence of karst features. Based on the results of these initial studies, the subsurface exploration program will be designed. In areas where karst features are expected to exist in roadway and retaining wall areas, additional electrical resistivity survey will be performed to assess the soil and rock profile with depth. Test borings will then be located at potential voids in the rock to confirm their existence. The results will then be used to mitigate the risks associated with the karst feature.

Mitigation/Solutions: In cases where there is flexibility in the structure or road alignment, it is ideal to shift the roadway alignment away from the feature; be it a shallow rock shelf, a cavity, or a soft soil filled void. In situations where the foundation elements or embankment cannot be shifted away from a cavity or sinkhole, H&A would suggest utilizing reverse filters which involve excavating the potential sinkhole to an identifiable throat then backfilling with riprap and stone transitioning from a large size at the bottom to small at the top followed by an aggregate suitable for paving or placement of a geotextile filter. Another method to remediate the condition is to utilize pressure grouting and high strength geogrids to stabilize the feature. The grouting operation involves drilling a pattern of small diameter holes and injecting various viscosity grouts. This technique is very effective against issues related to these karst features, however its expense is significant.

Soft Soil.

Above the top of rock stratum, the natural soils consist of elastic SILT, Fat CLAY and Lean CLAY with very low Standard Penetration Test (SPT) values. These soils are very compressible and will result in

settlement of structures and embankments when subjected to increased loading. The RFP specifies the post-construction settlement tolerances required for design. The Team is aware of these tolerances and will prepare our designs to meet these criteria.

One approach to meet the criteria is to not subject the soft compressible soil to additional loading (i.e. do not raise the grade enough to increase the stress on the compressible layer). If a grade raise causes an increased stress condition on the compressible soil, settlement analyses will be performed. If the stress increase will result in settlement that exceeds the settlement criteria, then the structure may need to be founded on deep foundations, or lightweight fill may need to be used in embankments. Where necessary we will induce surcharge loading to reduce potential for post-construction settlements that will exceed the specified criteria.

“Sliver Fill” Slopes.

For the proposed improvements to I-81, there are lengths of roadway which will require the construction of sliver fills. These embankment areas require the placement of fairly thin lifts of material over previously constructed embankments. There are several issues that must be watched, as improper construction of these embankments could result in slope failures that are difficult to remediate post-construction and can prove to be ongoing maintenance problems. A QA/QC plan will be developed to include specific items for the checklists such as the requirements for continuously benching slopes for new fills against existing embankments, as required by the specifications. In addition to benching, the condition of the base where the embankment begins is critical to ensure the stability of the embankment. If the base is unsuitable, it could cause the embankment to fail due a failure at the toe of the slope. The QA/QC staff will monitor this and work with the Geotechnical Engineer to ensure that the material at the base of the embankment is suitable. Further, the condition of the existing slope will be inspected to look for areas of existing failures or areas of moisture seepage that may require further improvement.

4.4.4 Quality Assurance/Quality Control

The Haymes Brothers Team’s approach to Design and Construction QA/QC follows the DBIA paradigm of having an integrated development of the design and construction program. The construction staff provides support and input during the design process while the design staff provides support and input during construction. Construction staff is engaged to ensure designs are constructible and tailored to support the most efficient sequence of work. Design staff continue support during construction to ensure design intent is achieved. This approach creates a partnership between the designers, the contractor’s field staff, the QC staff, and the QA staff for the duration of the project.

It is in every project participant’s interest that the QA/QC program is effective, as it reduces rework, ensures the constructed product is done safely, and ensures materials and methods meet the design intent and VDOT requirements. The QA/QC plan’s implementation during construction will determine the success of the project. To carry out these crucial functions we have developed the staffing plan below.

QA/QC Highlights

Quality Management Requiring Minimal VDOT Intervention

- ▶ Comprehensive, 3-level Design Quality Program
- ▶ Design discipline leads with more than 20 years’ experience on average
- ▶ Staff trained in VDOT’s CADAC system
- ▶ Experienced QAM, Chad McMurray, served as QAM on 3 recent VDOT Projects

DESIGN QA/QC » Roles & Responsibility

Design Manager (DM) » LAURA MEHIEL

- ✔ Reports to Henry and is responsible for coordinating individual design disciplines (including design subconsultants), and ensuring the overall project design is in conformance with the contract; Laura will develop the Design QA/QC plan, and will present the QA/QC plan to VDOT with Chuck, and perform QA on design documents prior to signing/sealing.

Design QA/QC Manager » FREDERICK WAGNER

- ✔ Reports to Laura, verifies the QC review, and evaluate whether the designer assessed the problem appropriately, applies the correct analysis, and was completed by qualified staff.

Interdisciplinary Reviewers

- ✔ Senior professionals from each discipline will review the work of other disciplines to ensure that potential conflicts are identified and resolved.

CONSTRUCTION » Roles & Responsibility

Design-Build Project Manager (DBPM) » HENRY HAYMES

- Responsible for the overall project design, construction quality management, and contractor administration for the project; partners with VDOT to resolve issues and disputes. Ensures environmental commitments/requirements are part of the “approved for construction” plans.

Quality Assurance Manager (QAM) » CHAD MCMURRAY

- Reports to Henry and VDOT and is completely independent of construction operations/production; responsible for QA inspection / testing materials used and work performed on the project, oversight of the construction QC program, develop, implement, and adjust the projects’ QA/QC Plan, maintain materials notebook and punch list.

Lead Quality Assurance Inspector

- Reports to Chad and manages a team of qualified/VDOT certified QA inspectors to execute the QA program; works closely with CM to verify QC staff qualifications and verify QC activities conform to the contract, QC program, and “approved for construction” plans

QA Inspection Technicians

- Report to Chad, completely independent from production, execute QA program and maintain authority/responsibility to initiate actions to prevent nonconforming work

CONSTRUCTION QA/QC » Roles & Responsibility

Construction Manager (CM) » ROBERT KENT BISHOP

- Reports to Henry and is on-site full-time for the duration of construction; manages the construction process, including QC activities, to ensure the materials used and work performed meets contract requirements and the approved plans; Eddie will communicate daily with Chuck to manage APM, utility, MOT, and other project risks.

Quality Control Manager (QCM) » CHUCK NEWMAN

- Reports to Robert, is responsible for QC inspection and inspectors, and ensures that QC requirements are completed in accordance with the QA/QC plan and the contract.

Construction Team Superintendents » EDWARD WARFE

- Reports to Robert, support detailed operation planning/production, and are empowered to stop or slow down production to quickly correct any defects that may arise; frequently consult with QCM and QC inspectors to coordinate inspection/testing for witness and hold points.

Quality Control Inspectors » CTI CONSULTANTS, INC.

- Report to Chuck, and are dedicated, full-time AC roadway and bridge inspectors that conduct required QC inspections/tests and report results/issues, if any, to Robert, Eddie, and Chuck.

a Design Quality Management

As Design Manager, Mrs. Laura Mehiel, PE, will have responsibility for implementation of quality control and quality assurance processes for all design elements of the project. The Design QC and QA Plan addresses procedures and responsibilities to ensure the project design is correct and consistent with appropriate standards and specifications. Each design submittal of plans, calculations, or reports, whether intermediate or final will be subject to an independent quality review of both Design QC and Design QA functions. Each review is finalized by a review summary form, which indicates by signature that the reviewer has completed the review and that the Design Manager (DM) has confirmed that all review comments have been properly incorporated. The review set of documents becomes a permanent part of the project files.

Design quality control reviews will look at a detail level to verify numerical accuracy and completeness of calculations and plans and conformance to VDOT standards and contract requirements. This review will assess coordination between disciplines, sub-consultants, and details, and will assure that the design is correctly reflected on the plans. This process makes extensive use of standardized checklists, including VDOT L&D-436, and materials developed in-house. Design quality assurance reviews will look at the “big picture” to verify completeness and reasonableness of the design

The image shows a VDOT Quality Control Checklist form. At the top left is the VDOT logo with the text 'LOCATION & DESIGN'. To the right, it says '2017 LD-436 Quality Control Checklist'. Below that, it specifies 'ROADWAY DESIGN' and 'State Project Number: PRJ05019225'. There are fields for 'VDC Number: 15346', 'VDOT District: Northern Virginia', 'Project Designer: Agustin', and 'Project Type: Detour'. A table on the right lists review items: 'Design Methodology', 'Applicable Codes', 'Applicable and Unapproved Materials', and 'Miscellaneous'. Below the table is a 'Submission' section with a list of items to be reviewed, each with a checkbox and a reference to a VDOT manual or standard. At the bottom, there is a signature line for the reviewer.

solution. The plan will also include conformance with contract requirements for each design discipline the following efforts as a minimum:

- ▶ All existing design data and calculations will be reviewed by the Design Engineer with an emphasis on engineering design and conformance with current VDOT standards in order to identify deficiencies. Deficiencies will be corrected as appropriate by the design engineer.
- ▶ The general geometry shown on the drawings will be reviewed by the Design Engineer to insure standards are met.
- ▶ Once all calculations have been verified using one of the methodologies stated above, the drawings will be checked by the QC Engineer to confirm that the design information has been correctly transferred to the plans.
- ▶ Quantity calculations will be confirmed by starting with the original calculations as compiled by the Design Engineer being checked by the QC Engineer and comparing the information to the final drawings.
- ▶ Special provisions and special provisions copied notes will be reviewed by the Design Engineer to confirm their applicability. Additional special provisions will be provided as necessary with the concurrence and approval of the Design Manager.

Comprehensive Approach: Key to project success is an integrated QA/QC process that includes the QC and QA staff, designers, contractors, and the design team's quality control checkers. The DM will also look at constructability, adequate right-of-way, possible utility conflicts, traffic maintenance issues, and interdisciplinary coordination. AMT and all design team members will work directly with Haymes personnel and the QAM to complete the constructability reviews of the plans to thoroughly ensure that all aspects of the project can be physically constructed in a safe manner. In addition to being safe, reviews will ensure the completed work is maintainable. This especially holds true for the impact the design will have on MOT. Items, such as material delivery / storage, workforce accessibility, and crane and other equipment placement will be reviewed to minimize traffic impacts. The DM will carry out his responsibilities by ensuring all QC and QA reviews are performed appropriately and by conducting monthly design meetings and special meetings for specific issues and concerns.

Subconsultants. The DM has the overall responsibility of managing and reviewing the designs by all subconsultants. The DM will task the Design QA/QC Manager, when not the DM, for various design components to provide direct oversight and quality assurance reviews of all subconsultants.

Design Changes during Construction. Any field changes or any other deviations to the approved construction documents will be subject to design QC and QA measures and procedures as applied to the original design. The requested change will be logged for tracking and will be sent to the Design Engineer who performed the original design. Once the change has been reviewed and the appropriate QC Engineer check performed, the requested change will be forwarded to the DM for approval. Once the DM has approved the change, it will be sent to the Design-Builder (Haymes) and ultimately to VDOT and/or other entity, as needed, with a recommendation for approval. If there are no comments, then the field change will be incorporated into the as-built plans. If comments are received, they will be forwarded back to the original designer and we will continue the process until the requested change is acceptable to VDOT and/or the appropriate entity.

In summary, the mission is to provide quality designs and plans in the fast-paced delivery of a design-build project. The key that drives success is effective communication among everyone involved with the design. QA/QC design procedures goals are to:

- ▶ Design elements that meet requirements, are constructible, durable, economical, inspectable, and minimize maintenance;
- ▶ Conform to the standards and reference documents in the RFP;
- ▶ Minimize design inefficiencies;
- ▶ Meet design schedule, budget, and construction staging requirements;
- ▶ Provide an organized and indexed set of design calculations, including design criteria and assumptions;
- ▶ Minimize VDOT review efforts

Detailed Design QA/QC Procedure.

There are three (3) levels in our Design Quality Plan. The Designer for each work element and the supporting project engineers, planners, and designers working under his/her direct supervision will originate the designs, plans and/or reports utilizing the project's completion checklist and perform the normal self-checking. Prior to each submittal review, the Designers for each work element will use standard checking procedures and the applicable elements of VDOT Checklist LD-436 (based on milestone) to document the detailed checking of all work prepared under their direction. This checking will include review against the Contract Documents /RFP Requirements; Project-Specific Design Criteria; VDOT Road Design Manual, Standards and Specifications; and Review Comments/ Resolutions.

Level 1 Production Quality Control

Our Quality Plan has a requirement for interdisciplinary reviews as part of the Level 1 QC Process. A multi-disciplinary team, including a Constructability Reviewer from Haymes Brothers, will review each design package to confirm compatibility among design elements, and capture the necessary modifications such that all design disciplines properly 'converge' in the final design.

Level 2 Independent Quality Control Check

The QC reviewers will utilize VDOT Checklist LD-436, and will also check the following items:

- › Math and engineering computations
- › Technical accuracy
- › Conformance to RFP / Contract requirements
- › Review of form, content, and spelling
- › Coordination with other disciplines
- › Sequence of construction logic
- › Verification that the drawings have been stamped, signed, and dated by a professional engineer licensed to perform work in VA

Level 3 Quality Assurance Check

- › Once all items in the design are acceptable to the designer and QC reviewer, the design will be advanced to the Design QA/QC Manager, Fred Wagner, P.E., for verification that established quality procedures have been followed.
- › QA audits may be performed, such as discipline-by-discipline review of the qualifications of the design staff, design analysis, a check on the adequacy of design discipline coordination, and a review of constructability issues.
- › The Quality Assurance Team is responsible for confirming that the design quality control review procedures are in place and being followed by each design discipline.
- › QA comments will be given to the designer and Laura for resolution and/or comment. Once all comments made by QC and QA reviewers have been satisfied the design will be certified by the Design Manager and sent to VDOT for review.

Level 1 production quality also requires close coordination with other disciplines and with the construction team to create a design that is compatible among disciplines and is constructible, efficient and cost effective. A formal interdisciplinary review and sign-off procedure is part of this process.

Once a design is generated, it will be forwarded for an in-house QC review overseen by QC Manager, Fred Wagner, PE. Fred will assign independent engineers that did not perform the original design, who will develop a list of recommended items for design refinement, correction, or clarification.

He will ensure that this QC process is performed on each design package during each phase of the design process. Each QC comment will be responded to by the designer, and sent back to the QC reviewer for concurrence.

A more detailed Quality Plan will be prepared for review by the Department within the first month after NTP. The Quality Plan will be in conformance with VDOT's Minimum Requirements for QA/QC on Design Build and PPTA Projects (2012), and will address specific protocols and minimum standards such as:

- › Identifying and correcting design non-conformances
- › Written certifications of design quality control prior to submissions and with monthly progress reports
- › Qualification requirements for independent reviewers/checkers
- › Quality Control Stamp and "red yellow blue" mark up procedures
- › Participation by the Department in QC Reviews
- › Quality control records retention

Unique Design QC/QA Element.

The geometry for the Haymes Brothers Team's bridges involves a very unique approach that introduces a curved alignment of the roadway striping, while keeping the bridge itself trapezoidal in shape. The curved roadway marking alignments across the straight-edged bridges result in variable width shoulders, which are always equal or greater than the minimum width required. The bridges are not parallel, and are of different overall widths. This "Common Sense Engineering" approach was taken to best optimize the re-alignment of I-81 southbound in the permanent condition, in an effort to minimize the total length of realignment, lessen the project schedule and resulting disruption to the traveling public, and reduce overall project cost. Further complicating matters is the substandard vertical clearance that exists today which must be addressed by raising the bridge profiles. What's more, the bridges will be widened in the future, and that widening must be considered during the design of this project, so that widening can be implemented without violating vertical clearance or other geometric design standards. Because of the uniqueness of this complex design effort, bridge geometry has been identified as the most critical design item, warranting special focus in the QA/QC process. We define below the process to be used by designers, and checked by independent reviews, for the bridge geometry design.

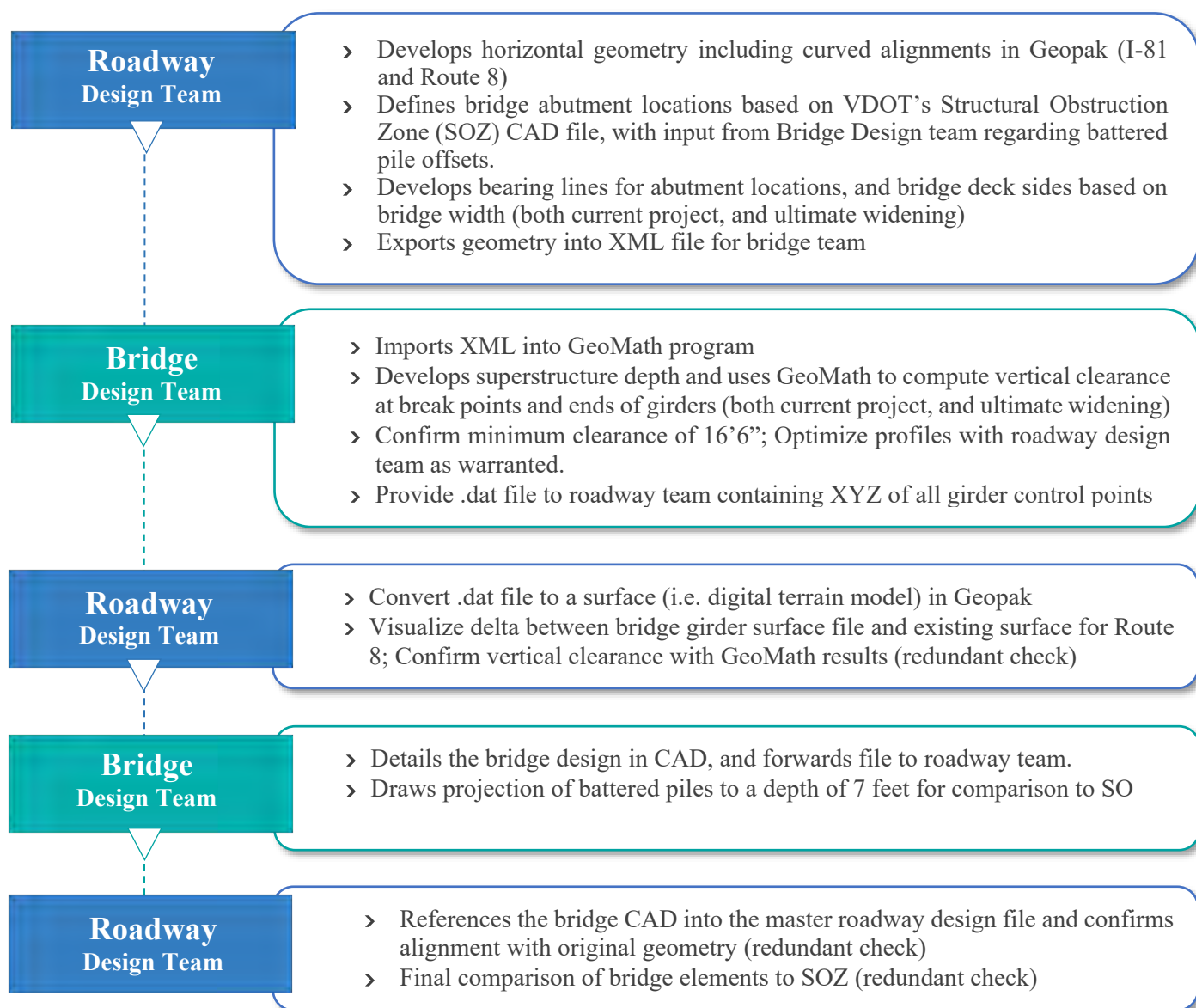

b Construction Quality Management

The QAM and Construction QA staff will provide construction observations and testing to evaluate construction processes relative to the applicable standards and specifications. The Construction QA staff will consist of two full-time, Lead QA Inspectors, one for grade and one for bridge, and one or more Support QA Inspectors, and Materials Testing Technicians, as needed to cover the work. The Lead QA Inspectors will report directly to the QAM and will be the on-site primary point of contact regarding Quality Assurance inspections. The Lead QA Inspectors will direct and coordinate the Support QA Inspectors and communicate regularly with QAM and QCM regarding construction status and quality-related issues.

The QCM will be responsible for monitoring the construction activities for compliance to the contract requirements and to provide the necessary documentation. Actual manpower requirements will be determined by the QCM based upon the levels of construction activities undertaken by Haymes Brothers Construction Company to adequately and properly monitor the work to be certified as required by the contract and the approved schedule; however, it is expected there will be no less than 2 Lead QC inspectors and 2 support QC inspectors and testing technicians throughout peak construction phases.

A list of checklists will be developed for the list of definable features of work. In addition, “*Inspection Checklists*” will be developed to assist the Inspectors in identifying the inspection requirements for each characteristic of a work package. Examples of the Inspection Checklists to be utilized on this project are included in the Appendix. As the project design is developed, any necessary checklists will be added and any changes to the checklists will be made and submitted as a revision to the QMSP.

Our plan includes phased inspections, performed prior to, during and after construction to assure it is being planned, performed and completed in accordance with the requirements of the Contract. Four phases of inspection, Preparatory, Intermediate, Completion and Punch-list, will be used to observe that the work is performed in general accordance with the contract documents. Additional information regarding each inspection phase is presented below.

Preparatory Phase Inspections: Preparatory phase inspections consist of conducting a Preparatory Meeting to ensure that project personnel have a thorough understanding of the upcoming work, to provide coordination and communication between the production, QC, and QA personnel and VDOT’s IA/IVST personnel. The preparatory meetings will confirm each party has the approved plans, materials, proper and functioning equipment, and personnel necessary for the work to be completed. Discussion topics will include the design intent of the work element, work schedule, QA/QC inspection and testing requirements, as well as identify production and inspection forces and their responsibilities.

Intermediate Phase Inspections: Intermediate inspections are performed when a representative segment of the work has been installed. During the intermediate inspections, relevant tests can be performed, quality of workmanship is examined and reviews for omissions or errors are performed. Non-conforming work is rejected. The goal of the intermediate inspections is to establish the acceptable level of quality and workmanship that is compliant with the Contract Documents, and which minimizes errors, avoids rework and keeps the project on schedule. During the Intermediate Phase of the inspection process, QA/QC personnel will observe that the methods and procedures established in the Preparatory Phase are maintained. The intermediate inspections will be performed on definable features of the work, against approved Construction Plans, Specifications and other related Contract Documents. The inspections performed will be detailed to include a description of the work element, deficiencies observed, corrective action identified and acceptance. Throughout the course of construction, the Design-Builder will accommodate VDOT’s performance of independent inspections.

Follow-Up Inspections: Completion Inspections allow QA/QC & VDOT to verify the construction has been completed per the contract documents, that the documentation for the work is complete and well organized. The project records and certifications will be submitted to support the Design-Builder’s application for final

payment as identified in the approved CPM schedule. If the record is incomplete, in error or misleading, a copy of the record will be returned with corrections noted. If chronic errors or omissions occur, the procedures by which the records are produced will be reviewed and corrected, as necessary.

Punch-list Inspections: The Haymes Brothers Design-Build Team will be responsible for completing items on the punch-list. The punch-list will be created by both VDOT and the QA/QC Personnel and maintained by the QA Manager. Punch lists will be created for each aspect of a work element during the various phases of work and be available for review at the time of Substantial Completion. Final payment may be delayed until punch list items have been completed to the satisfaction of VDOT.

Quality issues or deficiencies identified during the four-phase inspection process will be documented in the Inspector's Daily Reports as well as on the appropriate Inspection Checklists.

Unique Construction QC/QA Element.

We have identified our teams "top two" critical items that warrant diligent implementation and focused QA/QC: safe and effective maintenance of traffic, and concrete deck construction. Since we address maintenance of traffic in detail in Section 4.5, we have elected to highlight concrete deck construction here. A concrete deck that is not properly constructed will likely have an impact to the life of the structure, the serviceability of the structure, and impact the public through future closures necessary for repair or replacement work. Through ensuring proper construction methods and materials are used, The Haymes-AMT DB QA/QC Team can maximize the likelihood that the structure will design as performed and provide VDOT with a limited maintenance, long life-span structure.

Low Shrinkage Concrete: Due to the properties and curing characteristics of low shrinkage concrete, it is more susceptible to drying on the exposed surface before initial set is achieved throughout the mix. This can result in more plastic shrinkage occurring during placement. As such, it will be critically important to monitor evaporation rates and application of curing compound, burlap, fogging of the deck and the timeframes and conditions under which those items occur. Failing to follow the curing specifications increase the potential of cracks forming in the deck and as such will be monitored and communicated with the deck placement team to ensure the highest quality product is achieved.

The QA/QC will utilize checklists, preparatory meetings, materials invoices, materials sampling and testing to verify that the concrete deck is constructed in accordance with the required design and that the materials used meet or exceed the minimum specifications. As part of the approved project specific QA/QC Plan, a Preparatory Inspection Meeting will be held for the bridge deck pour as well as a pre-pour meeting immediately prior to the placement of the deck concrete. This preparatory meeting will be classified as a hold point in the schedule and representatives of the design-build contractor, subcontractor(s), quality control and quality assurance managers and inspectors will be required to attend. At the preparatory meeting, the checklist for the element of work will be reviewed and includes the preparatory, initial, and follow-up phases of inspection which include the following items:

Preparatory:

- › Review plans, specs, and shop drawings and confirm all documents are complete prior to initial start.
- › Have the QA/QC requirements QA/QC plan been approved and assembled?
- › Are the materials to be used or incorporated into the pour (i.e. reinforcing steel) approved and supplied from an approved supplier as indicated on the Source of Materials?
- › Is the mix design approved?
- › Has the QAM approved all equipment to be used?
- › Verify that the QA and QC inspectors performing materials testing are certified in concrete testing.

- › Verify that testing equipment has been calibrated within the past year, is clean, in good working condition.

Initial:

- › Verify dimensions and elevations of formwork
- › Formwork and reinforcement steel (correct size, type, grade, and placement) in accordance with contract documents?
- › Shop drawings submitted and approved for SIP metal decking?
- › Check deck screed for proper operation and grade including dry run and check to ensure minimum depth is met everywhere.
- › Verify weather/temperature limitations are within specified ranges.
- › Ensure authorization for the pumping of concrete is approved by the QAM.
- › Verify placement sequence in accordance with contract documents.
- › Observe placement and testing of concrete during placement and perform and document testing as per the QA/QC plan
- › Observe and document evaporation rate during placement.
- › Verify location of construction joints are in accordance with contract documents.
- › Ensure proper bonding and waterproofing of construction joints.
- › Verify welds, shear studs, inserts, anchorages, and other items to be encased in concrete are approved and meet contract requirements.
- › Verify forms and deck are clean and free of foreign matter before placement.

Follow-up

- › Did concrete attain proper strength prior to removal of formwork?
- › Did concrete attain proper strength prior to construction loads being permitted?
- › Was wet cure maintained as required for the proper timeframe?
- › Did the concrete attain proper strength at 28 days?
- › Verify depth checks are reviewed and approved by the structural engineer.
- › Does the concrete deck meet the requirements for rideability?

In addition to the above checklist items, a pre-pour meeting will also be held before the deck placement is scheduled to review all the pertinent information such as the mix design tolerances, testing station location, location of concrete pump, delivery route, back-up plan for equipment failure or concrete plant breakdown, safety procedures, concrete washout area, schedule and other related topics around the pour. Through the QA/QC team ensuring the items above have all been adequately addressed, the potential for concrete deck placement issues are minimized to the greatest extent practical and that the finished product will remain operable throughout its service life with minimal maintenance.

4.5 Construction of Project

4.5 CONSTRUCTION OF PROJECT

Construction Strategy

The Haymes Brothers Team understands the importance of designing and constructing this project with the goals of delivering the completed product to the Department and the travelling public safely, on-time and within budget, while minimizing disruptions to traffic flow and utilities during construction and preventing impacts to the environment. Considering this, the Haymes Brothers team has developed a sequence of construction that will safely and efficiently prosecute the work minimizing the duration of impacts and, consequently, reducing the risks to both the workers and the traveling public both vehicular and pedestrian.

Our team's overall strategy for the design and construction of the project is focused on providing maximum safety for the traveling public by minimizing the number of traffic shifts required during construction. Our design accomplishes this by shifting the entire SB bridge into the existing median and thereby eliminating the need to construct the SB bridge in phases as depicted in the VDOT conceptual design. **This approach will reduce the overall construction duration by several months** thereby assuring an early completion of the project and resulting in less exposure to construction zone hazards for the traveling public.

The Haymes Brothers Team concept will allow all phases to be constructed to the final design width of the roadway. This allows the fills for the roadway to be constructed with more separation from the existing traffic, eliminating shoring or wedging of the roadway that may be needed in the RFP concept design. This design also eliminates the need for restricted shoulder widths on the new SB structure during construction of the new NB bridge, which will also result in a safer project for the public. Another distinct advantage to our team's design is that the **bridge decks will not contain longitudinal joints or closure pours**, which will reduce the construction schedule, eliminate issues with public safety and construction safety, and will provide a better riding surface. Eliminating the closure pour in the deck will also eliminate issues with slowing or detouring traffic while the closure pour is being placed.

Haymes Brother's also sees a possibility for reduced total road closures at Rt. 8. With reduced phases of construction and by completing the entire bridge at each location for each phase, we believe we can **eliminate several of the total Route 8 closures** because all girders can be set at one time and all existing girder demolition can be done at one time.

Our design approach from project inception, used breast wall style abutments in lieu of the MSE wall with bent cap style abutments in the pre-addendum RFP plans. Despite the apparent cost efficiency of the MSE style, we feel that the potential for settlement in the karst geological area could present future problems for VDOT. Also, the MSE wall concept would not allow for future widening as easily as our breast wall design. This is because the MSE wall would have to be constructed to the full width of the future widening in this contract and the bearing piles for the abutment widening would need to be in place to avoid a future conflict with the MSE reinforcing grid. We note that with Addendum No 1, VDOT reached a similar conclusion.

Construction Highlights

Appropriate and Well-Thought Out Construction Sequencing

- Shifted entire SB bridge into the existing median, eliminating the need to construct the SB bridge in phases
- Baseline schedule will fully incorporate permit timeframes, TOY restrictions, ROW acquisition, and utility coordination

Mitigates Impacts to Traveling Public and Major Stakeholders

- All girders can be set at one time, and all existing girder demolition can be done at one time
- Bridge decks will not require closure pours "under traffic"
- Identified nearby route, if needed, to detour around major incidents near the project area

Enhances Safety during Construction

- Reduces duration of restricted shoulder widths
- Lower overall construction duration (removing work zones from the travel way)

By streamlining the phasing, we can eliminate traffic shifts, reduce the number of total road closures on Route 8, eliminate restricted width shoulders, and eliminate multiple deck pours. These items will all help to accelerate the construction schedule.

Aside from the specifics of the sequence of construction, Haymes Brothers Team will utilize risk management principles throughout the project life cycle developing a risk register shortly after the notice to award is given. This risk register will be discussed at all regularly scheduled design and construction coordination and monthly meetings and updated throughout the duration of the project. For the risks identified, mitigation strategies will be developed which will allow for timely resolution should those risks become reality and, thereby, minimizing or eliminating the impact to schedule and progress.

4.5.1 Sequence of Construction

The approach to sequencing and phasing the project is influenced by the requirements to maintain traffic in accordance with the Manual on Uniform Traffic Control Devices (MUTCD) and the Virginia WAPM while being developed to mitigate impacts to the traveling public, delays to construction, and facilitate project completion. In addition, the sequence of construction has been developed with the understanding that ongoing projects at Exit 105 and the Long-Term Water and Wastewater Extension Project along Route 8 have priority over this project and every effort shall be made to coordinate efforts with these ongoing projects to prevent delays to the project.

Upon Notice to Proceed (NTP), the Haymes Brothers Team will begin developing the roadway and bridge design plans, traffic maintenance plan (TMP), and environmental permitting on an accelerated schedule. Further, the Haymes Brother's Team will develop an advance work package to facilitate the early starts on temporary signals at the Route 8 ramps and the required work to rehabilitate and replace existing storm drains where required. The Team will also begin development of the QA/QC plan and hold public meetings to inform the public of the project, sequence of work, and project schedule.

The Team has broken this project into two (2) major phases with some preliminary work being done in advance of Phase I to expedite the start of the work.

Project Initiation – Mobilization and Start-up

- > Public outreach and stakeholder meetings
- > Installation of project construction signs
- > Mobilization including establishment of staging and storage area(s)
- > Documentation of existing conditions
- > Contact Miss Utility
- > Installation of Temporary signals at Route 8 ramps
- > Begin rehab and replace of existing storm drains

Phase IA – SB Bridge Construction

- > Traffic to utilize existing lanes
- > Install additional MOT as needed
- > Construct new SB bridge
- > Construct median retaining walls
- > Grade and pave approaches

Phase Narrative: We will install temporary shoring needed to excavate for abutment foundations, excavate abutment foundations, and construct substructure for the new SB structure. The new alignment and the elevation difference between the NB and SB roadways will require a retaining wall to separate the two. The retaining wall will be constructed during this phase.

We will construct the SB superstructure while concurrently grading the median for the new SB roadway alignment. The new SB structure will temporarily serve as the NB bridge while the existing NB bridge is demolished and replaced. Therefore, temporary tie-ins to the existing NB pavement will be constructed during this phase. Once paving, marking, guardrail and signage are installed, the NB traffic will be temporarily detoured to the new SB bridge.



Phase IB – Existing NB Bridge Demolition/New NB Bridge Construction

- > Shift NB traffic to new SB bridge and maintain SB traffic on existing bridge/lanes
- > Demolish existing NB bridge
- > Construct new NB bridge
- > Grade and pave approaches
- > Guardrail, seeding, signage for permanent NB

Phase Narrative: Using lane closures and flagging operations on Route 8 when necessary, the existing NB structure will be demolished and the new NB structure constructed. A temporary debris shield will be designed and constructed to protect pedestrians, bikers as well as vehicular traffic from any falling debris during both demolition and construction. Total closure and detour of Route 8 will be required to remove the existing girders and to erect the new girders, but will be limited to a total of ten occurrences as per the RFP. Concurrent with the construction of the new NB bridge, we will grade, pave and complete additional roadway work necessary to construct the new NB to its permanent configuration.

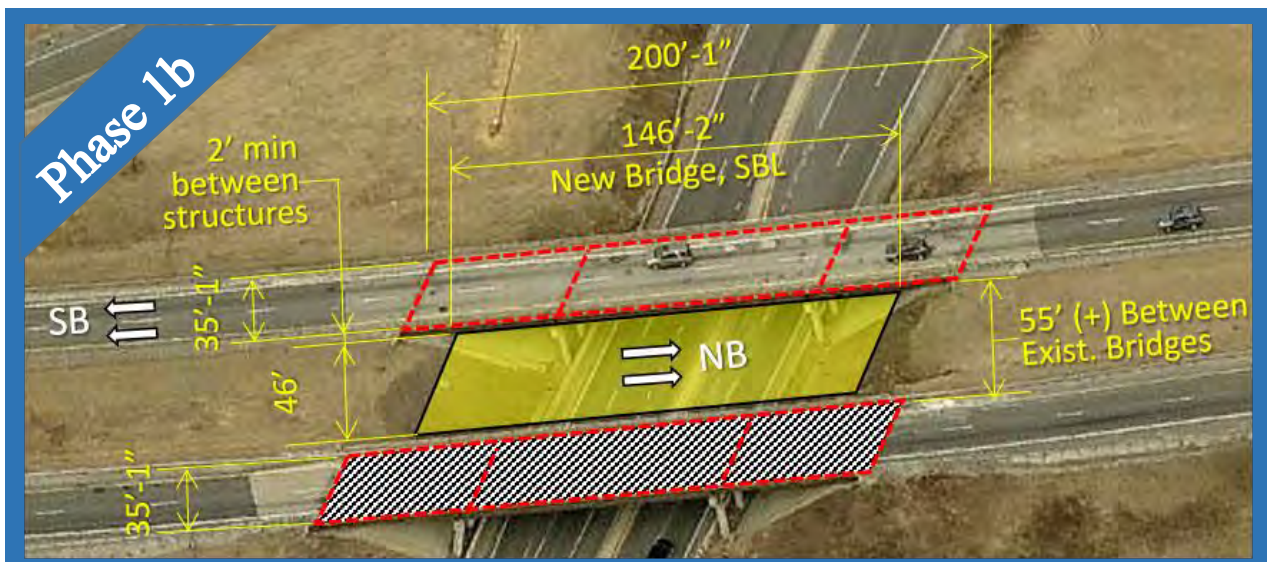

Phase IIA – SB Mainline Construction

- > Shift NB traffic to new NB and bridge
- > Demolish temporary pavement from NB tie-ins
- > Grade new SB tie-ins
- > Grade any remaining ramp tie-ins
- > Signs, guardrail, seeding for new SB

Phase Narrative: With SB traffic still using the existing SB bridge, NB traffic will be shifted from the temporary alignment on the new SB bridge to the final alignment on the new NB bridge. At this point temporary tie-ins to the NB will be removed and final grading, paving and ancillary work will be completed for the new SB alignment. Traffic will then be shifted from the old SB alignment and bridge to the new SB alignment and bridge to mark the start of Phase IIB.

Phase IIB – Demolish Existing SB Bridge

- > Shift SB from existing lanes to new lanes
- > Demolish old SB bridge
- > Remaining grading/widening of Route 8
- > Paving Route 8 and ramp tie-ins
- > Signs, guardrail, seeding Route 8

Phase Narrative: With I-81 now in its permanent alignment, the final construction of the ramp tie-ins to I-81 will be completed concurrent with the demolition of the old SB bridge as well as the old SB roadway. Once the old SB is removed, reconstruction of Route 8 will be completed.

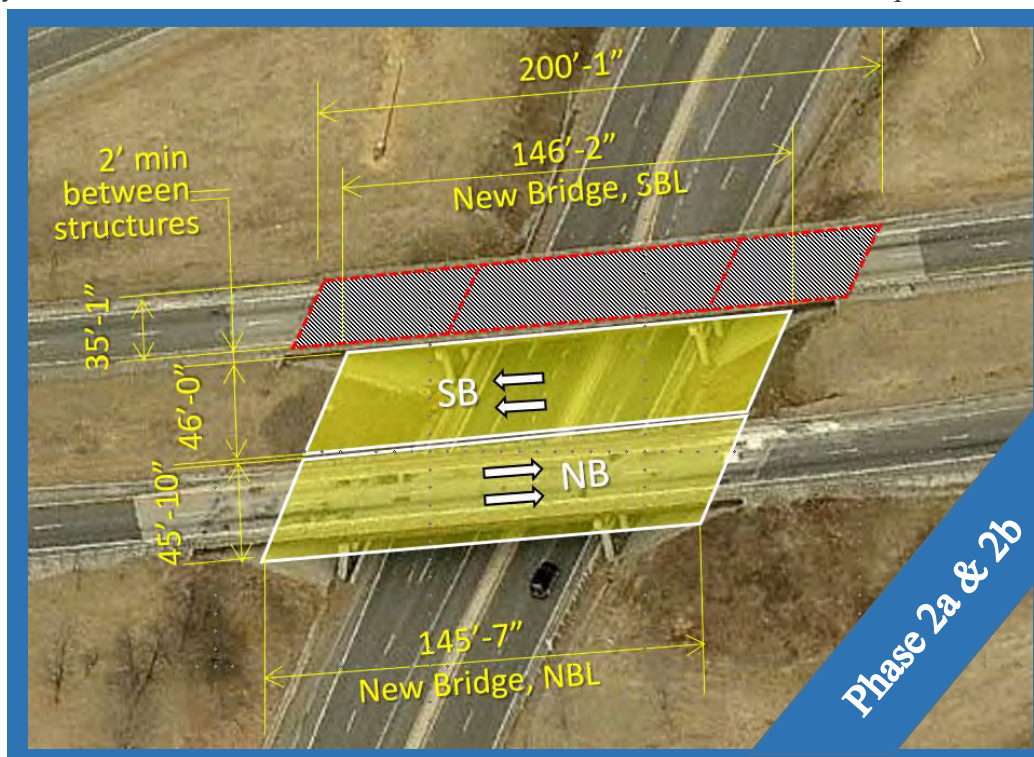

Closeout.

- > Final Clean-up
- > VDOT Final Inspection
- > Punchlist
- > Demobilization

Approach to Sequencing to Address Safety and Operations.

The Haymes Brothers Team recognizes the increased risks to safety that construction zones are prone to. Furthermore, we have reviewed the data made available to us by VDOT, including crash data in and around the project area. We note that on Route 8, the annual crash rate is more than 3 times the statewide average, and that I-81 and the ramps near Exit 114 experiences frequent incidents, three of which were fatalities in the past 5 years.

Figure 3.15 from VDOT’s Draft Interchange Modification Report (May 2016)

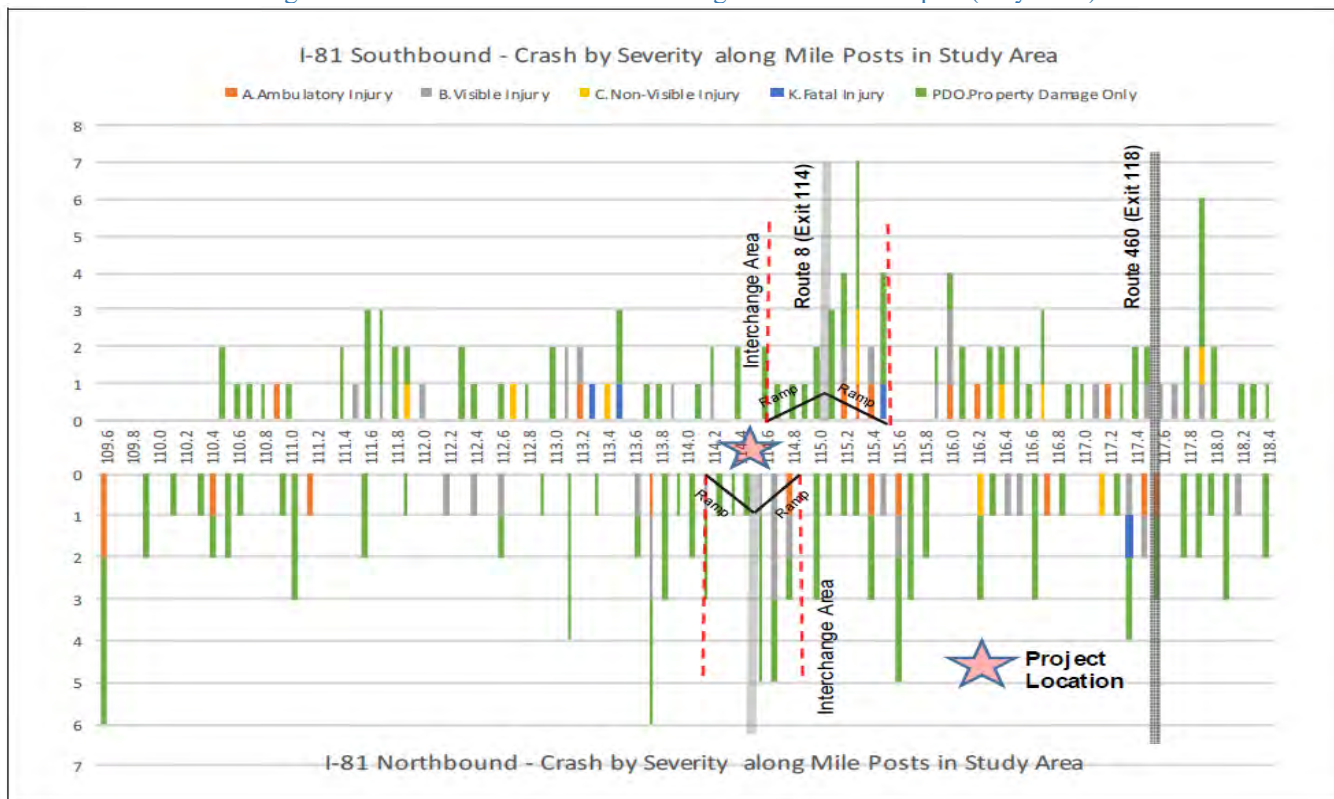

To adequately address safety and operations with the sequencing of construction, the Haymes Brothers Team identified several risks and developed mitigation strategies to address such risks, as summarized below.

RISK	MITIGATION
Working adjacent to traffic	<ul style="list-style-type: none"> – Develop/implement an effective TMP/MOT plan to minimize traffic disruptions. – Provide ATSSA and VDOT WZ Safety certified personnel to install and monitor effectiveness of MOT/TMP. – Enlist Designers to make changes if issues are noted
Construction vehicle access to work zone	<ul style="list-style-type: none"> – Design access to VDOT standards and address local site conditions – Clear delineation of entrances and closures during non-work periods – Provide safe access for construction vehicles accessing staging/storage yards
Night operations	<ul style="list-style-type: none"> – Proper illumination/retro-reflectivity of vehicles and employees – Lighted work zones and utilization of police support
Overhead work	<ul style="list-style-type: none"> – Properly delineating and securing demolition areas – Provide clearly marked and protected alternate access for pedestrians – Provide overhead protection systems
Fall protection	<ul style="list-style-type: none"> – Fall hazard training for field personnel – Use of fall protection systems where required
General on-site safety	<ul style="list-style-type: none"> – Development of a safety orientation video required for all personnel accessing the project site including Contractor, Designer, QA, QC, & VDOT staff.

Geotechnical Constraints.

Geotechnical constraints including possible unsuitable materials (soft soils) and karst geology have been evaluated and accounted for in the sequence of construction and schedule. To mitigate potential schedule delays due to these geotechnical constraints, we will continue to refine our approach and strategy, detailed in Section 4.4.3, for these critical elements prior to issuance of the approved for construction plans focusing on the following:

Karst Geology. Conducting an electrical resistivity survey prior to drilling test bores to identify potential karst features – mitigation strategies include shifting alignment or locations of structural elements away from identified voids, filling in those voids, or utilization of alternate foundations systems such as drilled shafts.

Soft Soils. Mitigation strategies include undercut and replacement or minimize or eliminate additional loading of the soft soils (i.e. keep the profile the same or similar to maintain the same levels of stress on the compressible layer.)

Environmental Impacts.

It is not anticipated that any phase of the work will impact T&E species or waters of the US. As such, plans will only require VSMP permit, VPDES certifications, development of the SWPPP sheets, and approved E&S plans. Appropriate hold points will be incorporated into the schedule to ensure these items are in place prior to work beginning.

ROW Impacts and Staging and Storage Areas.

Right of Way (ROW) acquisition of the permanent drainage easement from the church property will not be a on the critical path and will not impact the overall progress of the project. We will however need to develop agreements with property owners for potential borrow/disposal sites and storage/laydown/field office areas.

Possible Staging Locations. The Haymes Brothers Team has identified potential locations for staging and storage areas which have been evaluated for safe ingress/egress, environmental issues, and clearing requirements. It is clear that there are several available areas to develop adequate staging and storage areas that will facilitate safe and efficient construction of the project to maximize the potential for on-time completion. Our team has a verbal agreement with a property owner on Flanagan Drive for a field office site and staging area, and we have a secondary agreement with Crosspointe Church Conference Center. Following initial design efforts and work area assessments, a preferred site will be selected and secured in advance of construction.

Public Involvement/Stakeholder Coordination and Government Approvals.

The Haymes Brother’s Team will coordinate and maintain open lines of communication with all stakeholders throughout the design and construction of the project. For items requiring government approvals, periodic feedback on design efforts, especially MOT and construction sequencing will be requested through over-the-shoulder reviews to streamline input/approvals. We will request participation of VDOT and the Town of Christiansburg, utility companies, and community representatives in an informal partnering process facilitated by our team. Haymes Brother’s will utilize PCMS’s on approaches to the project to notify motorists of new and pending traffic pattern changes.



4.5.2 Transportation Management Plan

The proper planning of a construction project is critical in preventing unreasonable travel delays, promoting vehicular and worker safety, ensuring coordination between the contractor and agency officials and informing the public of upcoming construction activities. To facilitate the replacement of the I-81 Bridge at Exit 114, a Type B, Category IV Transportation Management Plan (TMP) will be developed per the VDOT IIM 241.6 (TED 351.4) and designed in accordance with the methodology provided in the Virginia Work Area Protection Manual (VA WAPM), 2011 Edition/Revised April 2015; the Manual on Uniform Traffic Control Devices (MUTCD), Year 2009 Edition; and the Virginia Supplement to the MUTCD, Year 2011 Edition/Revised September 2013. The TMP will consist of a Temporary Traffic Control Plan, a Transportation Operations Plan, including an Incident Management Plan, and a Public Communication Plan. Personnel involved in the design and implementation of the work zones will be experienced and certified with VDOT Advanced Work Zone Training.

Temporary Traffic Control Plans.

Temporary Traffic Control (TTC) plans, as detailed in the VA WAPM, will be the basis for the maintenance of traffic strategies to be implemented to enable the construction of the project. In accordance with the Sequence of Construction (SOC) approach described in the previous section, the following details the temporary traffic control to be utilized during each phase of construction:

Phase IA Traffic Control Measures.

- **NB I-81 Inside Shoulder Closure** to Install Temporary Pavement: TTC-6.1 (Shoulder Closure with Barrier Operation). The temporary pavement shall begin north of the existing overhead sign located to the south of the I-81 NB off-ramp.
- **NB I-81 Inside Lane Closure** to Tie into Temporary Pavement: TTC-17.1 (Inside Lane Closure on a Four Lane Roadway)
- **EB/WB Route 8 Lane Closures** to Construct SB Bridge: TTC-23.1 (Lane Closure on a Two-Lane Roadway Using Flaggers)
- **Install Temporary Traffic Signals** via a span wire installation at the intersections of Route 8 & I-81 NB ramps and Route 8 & I-81 SB ramps. The signals shall have emergency preemption, communication as well as advanced queue detectors long the I-81 off-ramps. A Signal Justification Report (SJR) shall be submitted by the Haymes Brothers Team and approved by VDOT's Southwest Region Operations (SWRO) prior to the installation of the traffic signals. Left-turn phasing requirements will be based upon an evaluation using VDOT's Guidance for Determination and Documentation of Left-Turn Phasing Mode.
- Improve the I-81 NB on-ramp access from WB Route 8 to accommodate the WB stop bar as required for the installation of the temporary traffic signals.

Phase IB Traffic Control Measures.

- **NB I-81 Shift to Temporary Pavement (per Phase 1)** to Construct the NB Bridge/ Approach: TTC-43.1 (Road Closure Operation with a Diversion)

A graphic showing the NB I-81 "detour alignment" is shown in Volume 2 of this proposal. The Haymes Brothers Team intends to use an MUTCD-compliant taper to transition traffic into the temporary pavement in the median south of the bridge, and 14,500' radius curve to transition traffic back on the north side of the bridge. The temporary alignment will then tie-in to the existing 5708' radius curve approximately 200 feet north of the ramp gore. Temporary striping and barrels will direct on- and off-ramp traffic appropriately into the NB I-81 detour pavement.

- > **EB/WB Route 8 Lane Closures** to Demolish/Construct NB Bridge: TTC-23.1 (Lane Closure on a Two-Lane Roadway Using Flaggers)

Phase IIA Traffic Control Measures.

- > **SB I-81 Inside Shoulder Closure** to Install Permanent Pavement: TTC-6.1 (Shoulder Closure with Barrier Operation)
- > **SB I-81 Inside Lane Closure** to Tie into Permanent Pavement: TTC-17.1 (Inside Lane Closure on a Four Lane Roadway)

Phase IIB Traffic Control Measures.

- > **SB I-81 Shift to Permanent Pavement** (per Phase 3) to demolish the SB Bridge: TTC-43.1 (Road Closure Operation with a Diversion)
- > **SB I-81 Outside Shoulder Closure** to reconstruct SB shoulder: TTC-6.1 (Shoulder Closure with Barrier Operation)
- > **SB I-81 Outside Lane Closure** to tie into shoulder improvements: TTC-16.1 (Outside Lane Closure on a Four Lane Roadway)
- > **EB/WB Route 8 Lane Closures** to demolish existing SB bridge: TTC-23.1 (Lane Closure on a Two-Lane Roadway Using Flaggers)

Minimum lane widths of 12-feet along I-81 shall be maintained during all phases of construction. It is expected that full access to the I-81 on/off ramps at Exit 114 will be maintained during each phase of construction. Shoulder lane, single lane and total roadway closures shall be in accordance with Section 2.10.3 of the RFP as per the table below:

Roadway	Day	Allowable Hours
I-81 NB/SB Shoulder Closure	Sunday – Friday	7PM – 6AM
I-81 NB/SB Single Lane Closure & I-81 Total Closure <i>(20-minute maximum)</i>	Monday – Thursday Friday Saturday Sunday	Midnight - 6AM, 9PM – Midnight Midnight – 6AM No Lane Closures 9PM - Midnight
Route 8 Single Lane Closure <i>(i.e. Flagger Operation)</i>	Monday – Sunday	7PM – 6AM, 9AM – 3PM
Route 8 Total Closure between I-81 On/Off Ramps - with Detour <i>(maximum of 10 occurrences)</i>	Friday – Saturday Saturday - Sunday	7PM – 7AM 7PM – 7AM

Note: Except as is necessary to maintain traffic within the work zones, construction activities shall not be permitted on the Holidays indicated in Section 108.02 of the VDOT 2016 Road and Bridge Specifications as well as during Radford University Graduation/move-in days, during Virginia Tech Graduation/move-in days/home football games and during Floyd Fest.

Our Team recognizes common shortfalls with the temporary traffic control plans (TTC) in work zones, and we are committed to avoiding these conditions with carefully designed site specific TTC plans. For example, it is critical to ensure that barrier ends and impact attenuators are flared away from traffic, as collisions with impact attenuators can result in high-severity crashes. Also, we know that temporary traffic barrier placement must be reviewed to ensure all turning movements and sight distances are maintained and that construction equipment will not prohibit any movements. Long continuous runs of temporary traffic barrier will be avoided ensuring adequate drainage and snow removal capabilities are maintained, and barrier will be promptly removed when it is no longer required.

Traffic Operations Plan.

Maintaining existing traffic operations, managing incidents and determining effective solutions to mitigate work zone impacts are key considerations for this project. As such, a Transportation Operations Plan will be developed as part of the TMP to provide detailed contact information for key VDOT personnel, establish an effective Incident Management Plan, provide a thorough traffic impact evaluation of proposed work zones and to document processes to coordinate with VDOT’s Southwest Region Operations (SWRO) Traffic Operations Center. The following is the most recent VDOT traffic data for I-81 and Route 8, respectively:

- ▶ **I-81, through Exit 114**, is a 4-lane divided interstate highway maintaining approximately 50,000 vehicles per day including over 25% trucks.
- ▶ **Route 8 (West Main Street)** is a 2-lane undivided minor arterial carrying approximately 14,000 vehicles per day with 2% trucks.

Our team’s **Incident Management Plan (IMP)** will provide field personnel with action plans in effort to decrease response times within work zones while increasing safety for first responders. The plan would contain guidelines for incident notification, categorized responses based upon incident type and expected duration as well as mitigation measures such as pre-established lane closures, detours and signing. This would include determining a detour option for Route 8 as well as a contingency plan for a temporary complete closure of I- 81 NB and/or SB for a period exceeding 20 minutes. Based upon a preliminary assessment, the following provides potential detour routes for I-81 and Route 8 are depicted below.

<u>I-81 NB Detour</u> ▶ Left on Route 177 at Exit 109; ▶ US 11 NB; ▶ US 11/US 460 Business NB; ▶ I-81 Ramp; ▶ I-81NB at Exit 118	<u>I-81 SB Detour</u> Exit 118B ▶ US 11/ US 460 Business ramp ▶ US 11/US 460 Business SB ▶ US 11 SB ▶ left on Route 177 ▶ I-81/Exit 109	<u>Route 8 WB Detour</u> – Left on Route 658 ▶ right on Route 600 /Route 177 (at I-81, Exit 109) ▶ right on Route 666 ▶ left on Route 8	<u>Route 8 EB Detour</u> Right on Route 666 ▶ left on Route 600/Route 177 (at I-81, Exit 109) ▶ left on Route 666 ▶ right on Route 8
--	---	---	--

VDOT’s Southwest Region Operations (SWRO) will be involved in the review and approval of the TMP, coordination with the VA State Police and the monitoring of traffic operations within work zones. The Haymes Brothers Team will also coordinate with contractors working in the vicinity of the interchange to enable uninterrupted traffic flow between adjacent projects.

Public Communications Plan.

Public Information. Public information and outreach is a vital component in managing the impacts to motorists and area residents. The TMP will include strategies to provide advanced notice of changes by way of VA511, Public Service Announcements, advertisements, existing Variable Message Signs (VMS) within the corridor, Portable Changeable Message Signs (PCMS) specific to the project, social media, including apps such as Waze and Google Maps, project websites, pardon our dust sessions, and any other reasonable means of dissemination to convey information to the roadway users. All information will be carefully coordinated with the Project’s overall Public Outreach campaign. Key stakeholders for this project include, but are not limited to: VDOT, FHWA, Town of Christiansburg, Montgomery County, Radford University, Virginia Tech, Virginia State Police, US Army Corps of Engineers, Montgomery County Regional Tourism, Floyd Fest, New River Valley Regional Commission and the Roanoke Valley Transportation Planning Organization (RVTPO).

During the **design phase**, the Haymes Brothers team will participate in required informational meetings with affected stakeholders to keep them informed of the overall project schedule and the potential impacts to adjacent property and travel patterns. Information will also be provided and updated on a routine basis in

order for VDOT to post appropriate and accurate information on its website. This information will include the project overview, plan of work, overall project schedule and progress, planning impacts to traffic, to include lane closures, shoulder closures, and planned traffic switches.

Our communication strategy will continue throughout the construction, with face to face interaction by our on-site personnel and the impacted parties and continued public meetings. It will also continue routinely with Portable Changeable Message Signs (PCMS) that will be deployed on I-81. The PCMS's will update all those traveling in and around the project of anticipated traffic switches, lane and/or shoulder closures, and any restrictions to include width restrictions as planned. The PCMS's will also be programmed with emergency messages that can be utilized for any unforeseen conditions notifying travelers of potential delay and alternate routes.

Mitigating Impacts on Stakeholders. Our Team recognizes that proactive communication with all project stakeholders (with assistance from VDOT) is essential. We have already identified the major project stakeholders, and we have devised specific mitigation strategies that exceed the Project requirements. These are summarized in the table below.

Stakeholders	Impacts	Communication/Mitigation Strategies
Traveling Public	Minimal travel time delays for temporary operations	<ul style="list-style-type: none"> ▶ All work operations behind barrier and will maximize lane widths ▶ Optimization of lane closure hours will limit closures on Route 8 ▶ Portable Changeable Message Signs and Twitter for public notices
Property Owners	Possible construction noise; construction activities on their property which will impact their access	<ul style="list-style-type: none"> ▶ Access to all properties maintained at all times ▶ Coordination of construction activities via notification and “Pardon Our Dust” meetings ▶ Work on each side street will be coordinated with residents and/or business so that work can be scheduled for hours of least impacts
Schools (7 within proximity)	Potential delays to school buses	<ul style="list-style-type: none"> ▶ Coordination of construction activities directly with school staff ▶ No lane closures during school bus operating hours when possible ▶ Advance notification of traffic pattern changes
Police, Fire & Rescue	Potential response time impact	<ul style="list-style-type: none"> ▶ Advance notification of temporary lane restrictions, changes to traffic patterns ▶ Representatives will be notified of approved lane closure requests ▶ Pre-switch emergency responder meetings for response planning 24/7 points of contact
Nearby Projects (described previously)	Construction coordination impacts between Projects	<ul style="list-style-type: none"> ▶ Temporary lane closures will be coordinated internally ▶ Long-term traffic control set-ups will be coordinated internally to ensure seamless traffic flow between projects ▶ Resources such as PCMS signs coordinated and shared for major events

4.6 DBE

4.6 DISADVANTAGED BUSINESS ENTERPRISES

Haymes Brothers, Inc. is committed to meeting the eight percent (8%) DBE participation goal for the entire value of the contract.

4.7 Schedule

4.7 PROPOSAL SCHEDULE

4.7.1 Proposal Schedule

The Haymes Brothers Team has prepared a Proposal Schedule and Proposal Schedule Narrative that depict our overall plan to accomplish the project required by Section 4.7 of the RFP. The Proposal Schedule includes activities for all work required to be accomplished in order to successfully complete the project on time. Our Proposal Schedule has taken into account all internal plan review, VDOT plan review and approvals, environmental permitting and constraints including time of year restrictions, right-of-way acquisition, utility relocation, construction activities and QA/QC inspection and testing. Our overall schedule approach allows us to achieve Final Completion by **July 19, 2021**.

4.7.2 Schedule Narrative

a. Design and Overall Plan to Accomplish Work.

The Proposal schedule consists of Design activities and the general sequence of construction activities. Immediately following Notice to Proceed, we will begin field surveys and investigations necessary for the design of the project. A complete design level survey will be completed and utility designations and locations will be completed along with geotechnical investigations and analyses. The Geotechnical Report will be finalized including required reviews by VDOT. Preliminary Roadway Design including associated Maintenance of Traffic/TMP, Drainage/SWM/E&S, will be completed, reviewed for quality, and then reviewed by VDOT. Concurrent with much of this design work, the structures design will be under way progressing through the Stage I and Stage II designs. These designs shall then be finalized and be in the QA/QC review in preparation for submittal to VDOT.

Other design related activities that will also be completed include securing required construction (VSMP, Water Quality, SWPPP) permits. The Roadway and Bridge Plans will then be completed and submitted to VDOT for further review before then being finalized. Upon finalization and Notice to Commence from VDOT work will begin and will be carried out following the submitted schedule, plans and other pertinent documents to ensure the project is completed safely, on time and on budget in accordance with all Standard, Specifications and other documents.

Additional Design and Utility Coordination Elements. Several elements of design are not set as separate activities in the Proposal Schedule as they are not expected to drive the critical path. One such example is development of standardized repair details for the existing bridge. The design of the temporary signals, which will become permanent as they will not be removed at project completion, will be completed concurrent with the TMP/MOT Design. Signing, marking and lighting plans will be included either with the roadway package, or as a separate package that will not delay the progress of construction. Coordination with Appalachian Power/Shentel Cable for potential relocation of the overhead line across I-81 will be programmed to allow for the relocation (as needed) prior to implementing the NB I-81 temporary detour pavement for Phase IB (summer 2019). All of these items will be fully detailed in the baseline schedule.

b. Administrative.

The project team will begin to submit all the initial contractually required submittals and documentation including the Letter of Submittal and the Attachments to the Letter of Submittal, the Price Proposal, QA/QC plan, Health and Safety plan, utility status report, geotechnical exploration plans, and insurance documentation and schedules.

c. Calendars.

The Proposal schedule contains 4 calendars:

Standard 5-Day

This calendar is used for all design and administrative activities as well as VDOT reviews;

7-Day

This calendar is used for cure times and various other activities that can run on a 7 day calendar;

Standard Construction

This calendar is for all non-paving construction activities that can be impacted by weather. This calendar includes holidays and an allowance for up to 4 weather impacted days each month;

Paving

This calendar is used for all paving activities and includes weather and holidays. No paving work is planned between December 15 and March 15 of any year.

d. Critical Path / Sequencing of Construction.

Sequence of Construction. The sequence of construction is as follows:

Project Initiation – Mobilization and Start-up

- Public outreach and stakeholder meetings
- Installation of project construction signs
- Mobilization including establishment of staging and storage area(s)
- Documentation of existing conditions
- Contact Miss Utility
- Installation of Temporary signals at Route 8 ramps
- Rehab and replace existing storm drain

Phase IA – SB Bridge Construction

- Traffic to utilize existing lanes
- Install additional MOT as needed
- Construct median side of new SBL bridge
- Construct median retaining walls
- Grade and pave approaches

Phase IB

- Shift NB traffic to new SB bridge and maintain SB traffic on existing bridge/lanes
- Demolish existing NBL bridge
- Construct new NBL bridge
- Grade and pave approaches
- Guardrail, seeding, signage for permanent NBL
- Shift NBL traffic to new NB and bridge

Phase IIA

- Demolish temporary pavement from NBL tie-ins
- Grade new SBL tie-ins
- Grade Ramp tie-ins
- Signs, guardrail, seeding for new SBL
- Shift SBL from existing lanes to new lanes

Phase IIB

- Demolish old SBL bridge
- Grading/Widening Route 8

- Paving Route 8 and Ramp Tie-ins
- Signs, guardrail, seeding Route 8

Closeout

- Final Clean-up
- VDOT Final Inspection
- Punchlist
- Demobilization

Explanation of Critical Path. This Critical Path shows the sequencing for construction to be carried on the I-81 Exit 114 Bridge Replacement Project. The following activities are networked together to determine the shortest possible timeframe to complete this project according to guidelines given by.

The critical path runs through the following activities:

- S1020 CTB Approval/Notice to Award
- S2410 TSL (Stage 1) and Bridge Foundation Package Design
- S2420 TSL (Stage 1) and Foundation Package Design QA/QC
- S2430 VDOT Review TSL (Stage 1) Foundation Design Package
- S2440 Address TSL (Stage 1) and Foundation Design Comments
- S2450 Resubmit Foundation Design Package
- S2460 VDOT Review Foundation Design Package 2nd submission
- S2470 RFC Plans Issued (Foundation)
- S1840 Excavate for Abutment Foundations (*SB*)
- S1850 Drive H Piles (*SB*)
- S1860 Substructure F/R/P (*SB*)
- S1890 Median retaining walls (*SB*)
- S1900 Girders and Superstructure (*SB*)
- S1910 F/R/P Deck (*SB*)
- S1940 F/R/P Approach Slab (*SB*)
- S1950 F/R/P Bridge Parapet (*SB*)
- S1960 Pave Approaches
- S1970 Shoulders, dress-up for Temp NBL Detour
- S1980 Temp. MOT for NBL Detour
- S1990 VDOT Inspect Phase IA bridge
- S2000 Punchlist VDOT inspection
- S2010 Shift NBL traffic to new SBL Bridge
- S2020 Complete Phase IA construction
- S2040 Demo Existing Bridge
- S2050 Excavate for abutment Foundations (*NB*)
- S2060 Drive H piles (*NB*)
- S2070 F/R/P Substructure (*NB*)
- S2080 QA Breaks on Substructure Conc (Hold Point) (*NB*)
- S2100 Girders and Superstructure (*NB*)

S2110	F/R/P Deck (NB)
S2140	F/R/P Approach Slabs (NB)
S2150	F/R/P Bridge Parapet (NB)
S2180	Pave Approaches
S2160	Shoulders/Dress-up for new NBL
S2170	Signs, Guardrail, Seeding New NBL
S2200	Shift NB traffic to new NBL
S2210	Phase IB Complete
S2220	Demo temp paving from NBL tie-ins
S2230	Grade New SBL Tie-ins
S2240	Grade Ramp Tie-ins
S2250	Pave new SBL and Ramp Tie-ins
S2260	Shoulders/Dress up for New SBL
S2270	Signs, Guardrail, Seeding for new SBL
S2280	Shift Traffic from Existing SBL to new SBL
S2290	Phase IIA Complete
S2310	Demo Existing SB Bridge
S2320	Grading/Widening Route 8
S2330	Paving Route 8 and Ramp Tie-ins
S2340	Shoulders/Dress up Route 8
S2350	Signs/Guardrail, Seeding Route 8
S2360	Phase IIB Complete
S2370	Final Clean-up
S2380	VDOT Final Inspection
S2390	Punchlist
S2400	Demobilization
S1200	No Excuse Incentive Date
S1210	Final Completion

Proposed Means and Methods. Means and Methods for constructing this project will follow all federal, state, and local guidelines. It will incorporate restrictions put on the project by VDOT. All work will adhere to pertinent Standard, Specification or Reference Documents and will be submitted to VDOT for review.

Key Assumptions. Include the following:

- ▶ NTP will be issued as shown on the schedule
- ▶ Survey work and some preliminary design will begin prior to NTP
- ▶ VDOT will complete reviews in the 21-calendar day timeframe shown
- ▶ VDOT will conduct reviews of the substructure and superstructure bridge plans separately to allow foundation work to begin early

Activity ID	Activity Name	Original Duration	Start	Finish	Calendar Grid																																							
					A	M	J	Jul	A	S	O	N	D	J	F	M	A	M	J	Jul	A	S	O	N	D	J	F	M	A	M	J	Jul	A	S	O	N	D	J	F	M	A	M	J	Jul
I-81 Exit 114 Proposal Schedule 2/26/18 Rev					02-Jul-21; I-81 Exit 11																																							
Administrative					02-Jul-21; Administrat																																							
S1000	Design Start - Pre-award activities	10	11-Apr-18	20-Apr-18	Design Start - Pre-award activities																																							
S1010	Notice of Intent to Award	0	11-Apr-18		◆ Notice of Intent to Award, 11-Apr-18																																							
S1020	CTB Approval/Notice to Award	0	09-May-18*		◆ CTB Approval/Notice to Award, 09-May-18*																																							
S1030	DB Contract Execution	0	06-Jun-18*		◆ DB Contract Execution, 06-Jun-18*																																							
S1040	Notice to Proceed	0	08-Jun-18*		◆ Notice to Proceed, 08-Jun-18*																																							
S1050	Scope Validation Period	120	08-Jun-18	05-Oct-18	Scope Validation Period																																							
S1060	Monthly Stakeholder meetings	420	08-Jun-18	18-Jun-20	Monthly Stakeholder meetings																																							
S1070	Prep Meeting E&S (Hold Point)	0	20-Jun-18		◆ Prep Meeting E&S (Hold Point), 20-Jun-18																																							
S1080	Prep Meeting Aggregate Base (Hold Point)	0	20-Jun-18		◆ Prep Meeting Aggregate Base (Hold Point), 20-Jun-18																																							
S1090	Prep Meeting Asphalt Paving (Hold Point)	0	20-Jun-18		◆ Prep Meeting Asphalt Paving (Hold Point), 20-Jun-18																																							
S1100	Prep Meeting Drainage (Hold Point)	0	20-Jun-18		◆ Prep Meeting Drainage (Hold Point), 20-Jun-18																																							
S1110	Prep Meeting Clearing and Grubbing (Hold Point)	0	20-Jun-18		◆ Prep Meeting Clearing and Grubbing (Hold Point), 20-Jun-18																																							
S1120	Prep Meeting Guardrail (Hold Point)	0	20-Jun-18		◆ Prep Meeting Guardrail (Hold Point), 20-Jun-18																																							
S1130	Prep Meeting Bridge Substructure (Hold Point)	0	20-Jun-18		◆ Prep Meeting Bridge Substructure (Hold Point), 20-Jun-18																																							
S1140	Prep Meeting Bridge Superstructure (Hold Point)	0	20-Jun-18		◆ Prep Meeting Bridge Superstructure (Hold Point), 20-Jun-18																																							
S1150	Prep Meeting Retaining Wall/MSE Wall (Hold Point)	0	20-Jun-18		◆ Prep Meeting Retaining Wall/MSE Wall (Hold Point), 20-Jun-18																																							
S1160	Prep Meeting MOT (Hold Point)	0	20-Jun-18		◆ Prep Meeting MOT (Hold Point), 20-Jun-18																																							
S1170	Prep Meeting Earthwork (Hold Point)	0	20-Jun-18		◆ Prep Meeting Earthwork (Hold Point), 20-Jun-18																																							
S1180	Utility Coordination/Review Meeting	0		20-Jun-18	◆ Utility Coordination/Review Meeting,																																							
S1200	No Excuse Incentive Date	0		02-Jul-21	◆ No Excuse Incentive																																							
S1210	Final Completion	0		02-Jul-21*	◆ Final Completion,																																							
Survey					25-May-18, Survey																																							
S1220	Send Survey Notification Letters	3	09-May-18	11-May-18	Send Survey Notification Letters																																							
S1230	Field Surveys	10	14-May-18	25-May-18	Field Surveys																																							
Geotechnical Investigation					08-Oct-18, Geotechnical Investigation																																							
S1240	Perform Soil Borings, GPR, etc., and Lab Work	22	08-Jun-18	10-Jul-18	Perform Soil Borings, GPR, etc., and Lab Work																																							
S1250	Prepare Geotechnical Report and Recommendations	18	11-Jul-18	03-Aug-18	Prepare Geotechnical Report and Recommendations																																							
S1260	QA/QC and Submit Geotech Report	5	06-Aug-18	10-Aug-18	QA/QC and Submit Geotech Report																																							
S1270	VDOT Review Geotech Report	21	10-Aug-18	31-Aug-18	VDOT Review Geotech Report																																							
S1280	Revise/Resubmit Geotech Report	10	04-Sep-18	17-Sep-18	Revise/Resubmit Geotech Report																																							
S1290	VDOT Review of revised Geotech Report	21	17-Sep-18	08-Oct-18	VDOT Review of revised Geotech Report																																							
Permitting					19-Sep-18, Permitting																																							
S1310	VSMP Permit - Initial Phase ESC and SWPPP	15	30-Apr-18	18-May-18	VSMP Permit - Initial Phase ESC and SWPPP																																							
S1320	Water Quality Permit/Wetland Permit Including Mitigation	100	30-Apr-18	19-Sep-18	Water Quality Permit/Wetland Permit Including Mitigation																																							
S1820	VSMP Permit Approval Hold Point	90	18-May-18	16-Aug-18	VSMP Permit Approval Hold Point																																							
Roadway Design and Advance Work Package					18-Jul-18, Roadway Design and Advance Work Package																																							
S1330	Roadway and ROW Package Design	30	09-May-18	20-Jun-18	Roadway and ROW Package Design																																							
S1340	Drainage/SWM/E&S	20	16-May-18	13-Jun-18	Drainage/SWM/E&S																																							
S1350	Maintenance of Traffic / TMP	20	23-May-18	20-Jun-18	Maintenance of Traffic / TMP																																							
S1360	Construcability/Interdisciplinary Reviews	5	21-Jun-18	27-Jun-18	Construcability/Interdisciplinary Reviews																																							
S1380	VDOT OTS Review	21	27-Jun-18	18-Jul-18	VDOT OTS Review																																							
Final Design					20-Dec-18, Final Design																																							
S1390	Roadway Plans/Incorporate/Resolve	20	08-Oct-18	02-Nov-18	Roadway Plans/Incorporate/Resolve																																							

█ Actual Level of Effort
 █ Remaining Work
 █ Critical Remaining Work
 ◆ Milestone
 ▾ summary

Activity ID	Activity Name	Original Duration	Start	Finish	Calendar Grid																																		
					Q							Q							Q							Q							Q						
					A	M	J	Jul	A	S	O	N	D	J	F	M	A	M	J	Jul	A	S	O	N	D	J	F	M	A	M	J	Jul	A	S	O	N	D		
S1400	Final Drainage/SWM/E&S + Modified SWPP/VPDES	10	05-Nov-18	16-Nov-18																																			
S1410	Maintenance of Traffic / TMP	10	05-Nov-18	16-Nov-18																																			
S1420	Prepare Roadway Plans for Submission	2	19-Nov-18	20-Nov-18																																			
S1430	Design QA/QC Review of Roadway Plans	5	21-Nov-18	29-Nov-18																																			
S1440	VDOT Review Final Design Plans	21	29-Nov-18	20-Dec-18																																			
Issued for Construction design		26	21-Dec-18	06-Feb-19																																			
S1450	Roadway Final Revisions	10	21-Dec-18	07-Jan-19																																			
S1460	Prepare RFC Roadway Plans for Submission	1	08-Jan-19	08-Jan-19																																			
S1470	VDOT Review RFC Plans	21	09-Jan-19	06-Feb-19																																			
S1480	RFC Roadway Plans Issued	0		06-Feb-19																																			
Structures Design		131	09-May-18	26-Dec-18																																			
Substructure Design		88	09-May-18	09-Oct-18																																			
S2410	TSL (Stage 1) and Bridge Foundation Package Design	35	09-May-18	09-Jul-18																																			
S2420	TSL (Stage 1) and Foundation Package Design QA/QC	8	10-Jul-18	23-Jul-18																																			
S2430	VDOT Review TSL (Stage 1) Foundation Design Package	21	24-Jul-18	13-Aug-18																																			
S2440	Address TSL (Stage 1) Foundation Design Comments	7	14-Aug-18	24-Aug-18																																			
S2450	Resubmit Foundation Design Package	5	28-Aug-18	04-Sep-18																																			
S2460	VDOT Review Foundation Design Package 2nd submission	21	05-Sep-18	09-Oct-18																																			
S2470	RFC Plans Issued	0		09-Oct-18																																			
Superstructure Design		88	24-Jul-18	26-Dec-18																																			
S2480	Bridge Superstructure Design package	26	24-Jul-18	06-Sep-18																																			
S2490	Superstructure Design QA/QC	5	07-Sep-18	14-Sep-18																																			
S2500	VDOT Review Superstructure Design	21	17-Sep-18	22-Oct-18																																			
S2510	Address Superstructure Comments	10	23-Oct-18	09-Nov-18																																			
S2520	Resubmit Superstructure Design	5	12-Nov-18	19-Nov-18																																			
S2530	VDOT Review Superstructure Design 2nd submission	21	20-Nov-18	26-Dec-18																																			
S2540	RFC Superstructure Plans Issued.	0		26-Dec-18																																			
Coordination		171	11-May-18	11-Mar-19																																			
S1600	Design Coordination meetings May 2018	0	11-May-18*																																				
S1610	Design Coordination Meetings June 2018	0	11-Jun-18*																																				
S1620	Design Coordination Meetings July 2018	0	09-Jul-18*																																				
S1630	Design Coordination Meetings August 2018	0	06-Aug-18*																																				
S1640	Design Coordination Meetings September 2018	0	08-Sep-18*																																				
S1650	Design Coordination Meetings October 2018	0	12-Oct-18*																																				
S1660	Design Construction Support November 2018	0	05-Nov-18*																																				
S1670	Design Construction Support Decemeber 2018	0	03-Dec-18*																																				
S1680	Design Construction Support January 2019	0	10-Jan-19*																																				
S1690	Design Construciton Support February 2019	0	11-Feb-19*																																				
S1700	Design Construction Support Remainder of project	0	11-Mar-19*																																				
Utility Relocations		37	06-Jun-18	07-Aug-18																																			
S2550	Lumos Utility Coordination	45	06-Jun-18	20-Jul-18																																			
S2560	Lumos Utility Relocation	10	23-Jul-18	07-Aug-18																																			
Construction		665	23-Apr-18	02-Jul-21																																			
S1710	Prepare QA/QC Plan	21	23-Apr-18	21-May-18																																			
S1720	Submit QA/QC Plan	1	22-May-18	22-May-18																																			

■ Actual Level of Effort ■ Remaining Work ◆ Milestone
■ Actual Work ■ Critical Remaining Work ▶ summary

Activity ID	Activity Name	Original Duration	Start	Finish	Calendar Grid																																							
					Q							Q							Q							Q							Q											
					A	M	J	Jul	A	S	O	N	D	J	F	M	A	M	J	Jul	A	S	O	N	D	J	F	M	A	M	J	Jul	A	S	O	N	D	J	F	M	A	M	J	Jul
S1730	VDOT Review QA/QC Plan	21	22-May-18	12-Jun-18	[Gantt bar: 22-May-18 to 12-Jun-18]																																							
S1740	Revise and Resubmit QA/QC Plan	5	13-Jun-18	19-Jun-18	[Gantt bar: 13-Jun-18 to 19-Jun-18]																																							
S1750	Submit Final QA/QC Plan	1	20-Jun-18	20-Jun-18	[Gantt bar: 20-Jun-18 to 20-Jun-18]																																							
S1770	Mobilization	10	18-Jul-18	06-Aug-18	[Gantt bar: 18-Jul-18 to 06-Aug-18]																																							
S1780	Begin Construction Activities	0	19-Jul-18		[Milestone: 19-Jul-18]																																							
S1790	Initial MOT	10	06-Aug-18	23-Aug-18	[Gantt bar: 06-Aug-18 to 23-Aug-18]																																							
S1830	Temporary Signals on Route 8 at Ramps	21	23-Aug-18	28-Sep-18	[Gantt bar: 23-Aug-18 to 28-Sep-18]																																							
S1800	Initial E&S Measures	5	20-Sep-18	26-Sep-18	[Gantt bar: 20-Sep-18 to 26-Sep-18]																																							
S2030	Rehab/replace existing storm drain	46	28-Sep-18	20-Dec-18	[Gantt bar: 28-Sep-18 to 20-Dec-18]																																							
S1810	Bridge Beam Fabrication	70	27-Dec-18	04-Apr-19	[Gantt bar: 27-Dec-18 to 04-Apr-19]																																							
Phase IA SB Bridge		196	10-Oct-18	20-Sep-19	[Summary bar: 10-Oct-18 to 20-Sep-19]																																							
S1840	Excavate for Abutment Foundations	8	10-Oct-18	23-Oct-18	[Gantt bar: 10-Oct-18 to 23-Oct-18]																																							
S1850	Drive H Piles	12	24-Oct-18	15-Nov-18	[Gantt bar: 24-Oct-18 to 15-Nov-18]																																							
S1860	Substructure F/R/P	60	16-Nov-18	01-Mar-19	[Gantt bar: 16-Nov-18 to 01-Mar-19]																																							
S1890	Median retaining walls	40	06-Feb-19	15-Apr-19	[Gantt bar: 06-Feb-19 to 15-Apr-19]																																							
S1870	QA Breaks on substructure concrete (Hold Point)	28	02-Mar-19	29-Mar-19	[Gantt bar: 02-Mar-19 to 29-Mar-19]																																							
S1880	Backfill Abutments with select material	13	05-Mar-19	25-Mar-19	[Gantt bar: 05-Mar-19 to 25-Mar-19]																																							
S1900	Girders and Superstructure	10	08-Apr-19	23-Apr-19	[Gantt bar: 08-Apr-19 to 23-Apr-19]																																							
S1920	Grade Median for Temp NBL	21	08-Apr-19	13-May-19	[Gantt bar: 08-Apr-19 to 13-May-19]																																							
S1910	F/R/P Deck	40	24-Apr-19	02-Jul-19	[Gantt bar: 24-Apr-19 to 02-Jul-19]																																							
S1930	QA Breaks on Deck Concrete (Hold Point)	28	03-Jul-19	30-Jul-19	[Gantt bar: 03-Jul-19 to 30-Jul-19]																																							
S1940	F/R/P Approach Slab	10	03-Jul-19	19-Jul-19	[Gantt bar: 03-Jul-19 to 19-Jul-19]																																							
S1950	F/R/P Bridge Parapet	10	23-Jul-19	07-Aug-19	[Gantt bar: 23-Jul-19 to 07-Aug-19]																																							
S1960	Pave Approaches	5	08-Aug-19	14-Aug-19	[Gantt bar: 08-Aug-19 to 14-Aug-19]																																							
S1970	Shoulders, dress-up for Temp NBL Detour	5	15-Aug-19	22-Aug-19	[Gantt bar: 15-Aug-19 to 22-Aug-19]																																							
S1980	Temp. MOT for NBL Detour	8	23-Aug-19	05-Sep-19	[Gantt bar: 23-Aug-19 to 05-Sep-19]																																							
S1990	VDOT Inspect Phase I bridge	2	06-Sep-19	09-Sep-19	[Gantt bar: 06-Sep-19 to 09-Sep-19]																																							
S2000	Punchlist VDOT inspection	2	11-Sep-19	12-Sep-19	[Gantt bar: 11-Sep-19 to 12-Sep-19]																																							
S2010	Shift NBL traffic to new SBL Bridge	5	13-Sep-19	20-Sep-19	[Gantt bar: 13-Sep-19 to 20-Sep-19]																																							
S2020	Complete Phase IA construction	0		20-Sep-19	[Milestone: 20-Sep-19]																																							
Phase IB NB Bridge		221	23-Sep-19	12-Oct-20	[Summary bar: 23-Sep-19 to 12-Oct-20]																																							
S2040	Demo Existing Bridge	30	23-Sep-19	12-Nov-19	[Gantt bar: 23-Sep-19 to 12-Nov-19]																																							
S2050	Excavate for abutment Foundations	10	14-Nov-19	02-Dec-19	[Gantt bar: 14-Nov-19 to 02-Dec-19]																																							
S2060	Drive H piles	12	03-Dec-19	23-Dec-19	[Gantt bar: 03-Dec-19 to 23-Dec-19]																																							
S2070	F/R/P Substructure	60	24-Dec-19	07-Apr-20	[Gantt bar: 24-Dec-19 to 07-Apr-20]																																							
S2080	QA Breaks on Substructure Conc (Hold Point)	28	08-Apr-20	05-May-20	[Gantt bar: 08-Apr-20 to 05-May-20]																																							
S2090	Backfill Abutments w/ Select Material	14	09-Apr-20	01-May-20	[Gantt bar: 09-Apr-20 to 01-May-20]																																							
S2100	Girders and Superstructure	10	05-May-20	21-May-20	[Gantt bar: 05-May-20 to 21-May-20]																																							
S2110	F/R/P Deck	45	22-May-20	06-Aug-20	[Gantt bar: 22-May-20 to 06-Aug-20]																																							
S2120	Grade Approaches for new NBL	20	22-May-20	24-Jun-20	[Gantt bar: 22-May-20 to 24-Jun-20]																																							
S2130	QA Break on Deck Concrete (Hold Point)	28	07-Aug-20	03-Sep-20	[Gantt bar: 07-Aug-20 to 03-Sep-20]																																							
S2140	F/R/P Approach Slabs	10	07-Aug-20	24-Aug-20	[Gantt bar: 07-Aug-20 to 24-Aug-20]																																							
S2150	F/R/P Bridge Parapet	10	25-Aug-20	09-Sep-20	[Gantt bar: 25-Aug-20 to 09-Sep-20]																																							
S2180	Pave Approaches	7	10-Sep-20	18-Sep-20	[Gantt bar: 10-Sep-20 to 18-Sep-20]																																							
S2190	VDOT Inspect Phase II Bridge	2	10-Sep-20	11-Sep-20	[Gantt bar: 10-Sep-20 to 11-Sep-20]																																							
S2300	Punchlist VDOT Inspection	5	14-Sep-20	21-Sep-20	[Gantt bar: 14-Sep-20 to 21-Sep-20]																																							
S2160	Shoulders/Dress-up for new NBL	5	21-Sep-20	28-Sep-20	[Gantt bar: 21-Sep-20 to 28-Sep-20]																																							

█ Actual Level of Effort
 █ Remaining Work
 █ Critical Remaining Work
 ◆ Milestone
 ── summary

APPENDICES

APPENDICES

a. Technical Proposal Checklist

ATTACHMENT 4.0.1.1
I-81 Bridge Replacement at Exit 114
TECHNICAL PROPOSAL CHECKLIST AND CONTENTS

Offerors shall furnish a copy of this Technical Proposal Checklist, with the page references added, with the Technical Proposal.

Technical Proposal Component	Form (if any)	RFP Part 1 Cross Reference	Included within page limit?	Technical Proposal Page Reference
Technical Proposal Checklist and Contents	Attachment 4.0.1.1	Section 4.0.1.1	no	
Acknowledgement of RFP, Revisions, and/or Addenda	Attachment 3.6 (Form C-78-RFP)	Sections 3.6, 4.0.1.1	no	
Letter of Submittal	NA	Sections 4.1		
Letter of Submittal on Offeror's letterhead	NA	Section 4.1.1	yes	1
Identify the full legal name and address of Offeror	NA	Section 4.1.1	yes	1
Authorized representative's original signature	NA	Section 4.1.1	yes	1
Declaration of intent	NA	Section 4.1.2	yes	1
120 day declaration	NA	Section 4.1.3	yes	1
Point of Contact information	NA	Section 4.1.4	yes	1
Principal Officer information	NA	Section 4.1.5	yes	1
Interim Milestone and Final Completion Date(s)	NA	Section 4.1.6	yes	1
Proposal Payment Agreement or Waiver of Proposal Payment	Attachment 9.3.1 or 9.3.2	Section 4.1.7	no	
Certification Regarding Debarment Forms	Attachment 11.8.6(a) Attachment 11.8.6(b)	Section 4.1.8	no	
Offeror's Qualifications	NA	Section 4.2		

ATTACHMENT 4.0.1.1

I-81 Bridge Replacement at Exit 114

TECHNICAL PROPOSAL CHECKLIST AND CONTENTS

Technical Proposal Component	Form (if any)	RFP Part 1 Cross Reference	Included within page limit?	Technical Proposal Page Reference
Confirmation that the information provided in the SOQ submittal remains true and accurate or indicates that any requested changes were previously approved by VDOT	NA	Section 4.2.1	yes	2
Organizational chart with any updates since the SOQ submittal clearly identified	NA	Section 4.2.2	yes	3
Revised narrative when organizational chart includes updates since the SOQ submittal	NA	Section 4.2.2	yes	2
Design Concept	NA	Section 4.3		4-13
Conceptual Roadway Plans and description	NA	Section 4.3.1.1	yes	4
Conceptual Structural Plans and description	NA	Section 4.3.1.2	yes	9
Project Approach	NA	Section 4.4		14-31
Environmental Management	NA	Section 4.4.1	yes	14
Utilities	NA	Section 4.4.2	yes	18
Geotechnical	NA	Section 4.4.3	yes	22
Quality Assurance/ Quality Control (QA/QC)	NA	Section 4.4.4	yes	24
Construction of Project	NA	Section 4.5		32-41
Sequence of Construction	NA	Section 4.5.1	yes	32
Transportation Management Plan	NA	Section 4.5.2	yes	38

ATTACHMENT 4.0.1.1

I-81 Bridge Replacement at Exit 114

TECHNICAL PROPOSAL CHECKLIST AND CONTENTS

Technical Proposal Component	Form (if any)	RFP Part 1 Cross Reference	Included within page limit?	Technical Proposal Page Reference
Disadvantaged Business Enterprises (DBE)	NA	Section 4.6		42
Written statement of percent DBE participation	NA	Section 4.6	yes	42
Proposal Schedule	NA	Section 4.7		
Proposal Schedule	NA	Section 4.7	no	
Proposal Schedule Narrative	NA	Section 4.7	no	
Proposal Schedule in electronic format (CD-ROM)	NA	Section 4.7	no	

APPENDICES

b. Acknowledgement of RFP, Revision(s) & Addenda(s)

ATTACHMENT 3.6

**COMMONWEALTH OF VIRGINIA
DEPARTMENT OF TRANSPORTATION**

RFP NO. C00093074DB96
PROJECT NO.: 0081-154-733

ACKNOWLEDGEMENT OF RFP, REVISION AND/OR ADDENDA

Acknowledgement shall be made of receipt of the Request for Proposals (RFP) and/or any and all revisions and/or addenda pertaining to the above designated project which are issued by the Department prior to the Letter of Submittal submission date shown herein. Failure to include this acknowledgement in the Letter of Submittal may result in the rejection of your proposal.

By signing this Attachment 3.6, the Offeror acknowledges receipt of the RFP and/or following revisions and/or addenda to the RFP for the above designated project which were issued under cover letter(s) of the date(s) shown hereon:

1. Cover letter of RFP – October 23, 2017
(Date)
2. Cover letter of Addendum #1 - February 6, 2018
(Date)
3. Cover letter of _____
(Date)

 _____
SIGNATURE 3-2-18
DATE

HENRY A. HAYMES _____
PRINTED NAME V.P.
TITLE

APPENDICES

c. Proposal Payment Agreement

ATTACHMENT 9.3.1
PROPOSAL PAYMENT AGREEMENT

THIS PROPOSAL PAYMENT AGREEMENT (this "Agreement") is made and entered into as of this ___ day of _____, 20___, by and between the Virginia Department of Transportation ("VDOT"), and HAYNES BROTHERS, INC. ("Offeror").

WITNESSETH:

WHEREAS, Offeror is one of the entities who submitted Statements of Qualifications ("SOQs") pursuant to VDOT's July 12, 2017 Request for Qualifications ("RFQ") and was invited to submit proposals in response to a Request for Proposals ("RFP") for the **I-81 Bridge Replacement at Exit 114, Project No. 0081-154-733** ("Project"), under a design-build contract with VDOT ("Design-Build Contract"); and

WHEREAS, as part of the procurement process for the Project, Offeror has already provided and/or furnished to VDOT, and may continue to provide and/or furnish to VDOT, certain intellectual property, materials, information and ideas, including, but not limited to, such matters that are: (a) conveyed verbally and in writing during proprietary meetings or interviews; and (b) contained in, related to or associated with Offeror's proposal, including, but not limited to, written correspondence, designs, drawings, plans, exhibits, photographs, reports, printed material, tapes, electronic disks, or other graphic and visual aids (collectively "Offeror's Intellectual Property"); and

WHEREAS, VDOT is willing to provide a payment to Offeror, subject to the express conditions stated in this Agreement, to obtain certain rights in Offeror's Intellectual Property, provided that Offeror submits a proposal that VDOT determines to be responsive to the RFP ("Offeror's Proposal"), and either (a) Offeror is not awarded the Design-Build Contract; or (b) VDOT cancels the procurement or decides not to award the Design-Build Contract to any Offeror; and

WHEREAS, Offeror wishes to receive the payment offered by VDOT, in exchange for granting VDOT the rights set forth in this Agreement.

NOW, THEREFORE, in consideration of the mutual covenants and agreements set forth in this Agreement and other good and valuable consideration, the receipt and adequacy of which are acknowledged by the parties, the parties agree as follows:

1. **VDOT's Rights in Offeror's Intellectual Property.** Offeror hereby conveys to VDOT all rights, title and interest, free and clear of all liens, claims and encumbrances, in Offeror's Intellectual Property, which includes, without restriction or limitation, the right of VDOT, and anyone contracting with VDOT, to incorporate any ideas or information from Offeror's Intellectual Property into: (a) the Design-Build Contract and the Project; (b) any other contract awarded in reference to the Project; or (c) any subsequent procurement by VDOT. In receiving all rights, title and interest in Offeror's Intellectual Property, VDOT is deemed to own all intellectual property rights, copyrights, patents, trade secrets, trademarks, and service marks in Offeror's Intellectual Property, and Offeror agrees that it shall, at the request of VDOT, execute all papers and perform all other acts that may be necessary to ensure that VDOT's rights, title and interest in Offeror's Intellectual Property are protected. The rights conferred herein to VDOT include, without limitation, VDOT's ability to use Offeror's Intellectual Property without the obligation to notify or seek permission from Offeror.

2. **Exclusions from Offeror's Intellectual Property.** Notwithstanding Section 1 above, it is understood and agreed that Offeror's Intellectual Property is not intended to include, and Offeror does not convey any rights to, the Escrow Proposal Documents submitted by Offeror in accordance with the RFP.

3. **Proposal Payment.** VDOT agrees to pay Offeror the lump sum amount of **thirty thousand and 00/100 Dollars (\$30,000.00)** ("Proposal Payment"), which payment constitutes payment in full to Offeror for the conveyance of Offeror's Intellectual Property to VDOT in accordance with this Agreement. Payment of the Proposal Payment is conditioned upon: (a) Offeror's Proposal being, in the sole discretion of VDOT, responsive to the RFP; (b) Offeror complying with all other terms and conditions of this Agreement; and (c) either (i) Offeror is not awarded the Design-Build Contract, or (ii) VDOT cancels the procurement or decides not to award the Design-Build Contract to any Offeror.

4. **Payment Due Date.** Subject to the conditions set forth in this Agreement, VDOT will make payment of the Proposal Payment to the Offeror within forty-five (45) days after the later of: (a) notice from VDOT that it has awarded the Design-Build Contract to another Offeror; or (b) notice from VDOT that the procurement for the Project has been cancelled and that there will be no Contract Award.

5. **Effective Date of this Agreement.** The rights and obligations of VDOT and Offeror under this Agreement, including VDOT's ownership rights in Offeror's Intellectual Property, vests upon the date that Offeror's Proposal is submitted to VDOT. Notwithstanding the above, if Offeror's Proposal is determined by VDOT, in its sole discretion, to be nonresponsive to the RFP, then Offeror is deemed to have waived its right to obtain the Proposal Payment, and VDOT shall have no obligations under this Agreement.

6. **Indemnity.** Subject to the limitation contained below, Offeror shall, at its own expense, indemnify, protect and hold harmless VDOT and its agents, directors, officers, employees, representatives and contractors from all claims, costs, expenses, liabilities, demands, or suits at law or equity ("Claims") of, by or in favor of or awarded to any third party arising in whole or in part from: (a) the negligence or wilful misconduct of Offeror or any of its agents, officers, employees, representatives or subcontractors; or (b) breach of any of Offeror's obligations under this Agreement, including its representation and warranty under Section 8 hereof. This indemnity shall not apply with respect to any Claims caused by or resulting from the sole negligence or wilful misconduct of VDOT, or its agents, directors, officers, employees, representatives or contractors.

7. **Assignment.** Offeror shall not assign this Agreement, without VDOT's prior written consent, which consent may be given or withheld in VDOT's sole discretion. Any assignment of this Agreement without such consent shall be null and void.

8. **Authority to Enter into this Agreement.** By executing this Agreement, Offeror specifically represents and warrants that it has the authority to convey to VDOT all rights, title, and interest in Offeror's Intellectual Property, including, but not limited to, those any rights that might have been vested in team members, subcontractors, consultants or anyone else who may have contributed to the development of Offeror's Intellectual Property, free and clear of all liens, claims and encumbrances.

9. **Miscellaneous.**

a. Offeror and VDOT agree that Offeror, its team members, and their respective employees are not agents of VDOT as a result of this Agreement.

b. Any capitalized term used herein but not otherwise defined shall have the meanings set forth in the RFP.

c. This Agreement, together with the RFP, embodies the entire agreement of the parties with respect to the subject matter hereof. There are no promises, terms, conditions, or obligations other than those contained herein or in the RFP, and this Agreement shall supersede all previous communications, representations, or agreements, either verbal or written, between the parties hereto.

d. It is understood and agreed by the parties hereto that if any part, term, or provision of this Agreement is by the courts held to be illegal or in conflict with any law of the Commonwealth of Virginia, validity of the remaining portions or provisions shall not be affected, and the rights and obligations of the parties shall be construed and enforced as if the Agreement did not contain the particular part, term, or provisions to be invalid.

e. This Agreement shall be governed by and construed in accordance with the laws of the Commonwealth of Virginia.

IN WITNESS WHEREOF, this Agreement has been executed and delivered as of the day and year first above written.

VIRGINIA DEPARTMENT OF TRANSPORTATION

By: _____

Name: _____

Title: _____

[Insert Offeror's Name] *HAYMES BROTHERS, INC.*

By: *Henry A. Haymes* _____

Name: *HENRY A. HAYMES* _____

Title: *VICE PRESIDENT* _____

APPENDICES

d. Certification Regarding Debarment

ATTACHMENT 11.8.6(a)
CERTIFICATION REGARDING DEBARMENT
PRIMARY COVERED TRANSACTIONS

Project No.: 0081-154-733

1) The prospective primary participant certifies to the best of its knowledge and belief, that it and its principals:

a) Are not presently debarred, suspended, proposed for debarment, declared ineligible, or voluntarily excluded from covered transactions by any Federal department or agency.

b) Have not within a three-year period preceding this proposal been convicted of or had a civil judgment rendered against them for commission of fraud or a criminal offense in connection with obtaining, attempting to obtain, or performing a public (Federal, State or local) transaction or contract under a public transaction; and have not been convicted of any violations of Federal or State antitrust statutes or commission of embezzlement, theft, forgery, bribery, falsification, or destruction of records, making false statements, or receiving stolen property;

c) Are not presently indicted for or otherwise criminally or civilly charged by a governmental entity (Federal, State or local) with commission of any of the offenses enumerated in paragraph 1) b) of this certification; and

d) Have not within a three-year period preceding this application/proposal had one or more public transactions (Federal, State or local) terminated for cause or default.

2) Where the prospective primary participant is unable to certify to any of the statements in this certification, such prospective participant shall attach an explanation to this proposal.

The undersigned makes the foregoing statements to be filed with the proposal submitted on behalf of the Offeror for contracts to be let by the Commonwealth Transportation Board.

 Signature	3-2-18 Date	Vice Pres. Title
--	----------------	---------------------

Haymes Brothers, Inc.
Name of Firm

APPENDICES

- e. Certification Regarding Debarment
Lower Tier Covered Transactions

ATTACHMENT 11.8.6(b)
CERTIFICATION REGARDING DEBARMENT
LOWER TIER COVERED TRANSACTIONS

Project No.: 0081-154-733

1) The prospective lower tier participant certifies, by submission of this proposal, that neither it nor its principals is presently debarred, suspended, proposed for debarment, declared ineligible, or voluntarily excluded from participation in this transaction by any Federal department or agency.

2) Where the prospective lower tier participant is unable to certify to any of the statements in this certification, such prospective participant shall attach an explanation to this proposal.

The undersigned makes the foregoing statements to be filed with the proposal submitted on behalf of the Offeror for contracts to be let by the Commonwealth Transportation Board.

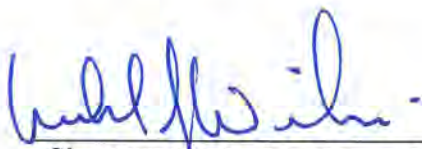

Signature Michael J. Wiercinski

02/23/18

Date

Principal

Title

A. Morton Thomas and Associates, Inc.

Name of Firm

ATTACHMENT 11.8.6(b)
CERTIFICATION REGARDING DEBARMENT
LOWER TIER COVERED TRANSACTIONS

Project No.: 0081-154-733

1) The prospective lower tier participant certifies, by submission of this proposal, that neither it nor its principals is presently debarred, suspended, proposed for debarment, declared ineligible, or voluntarily excluded from participation in this transaction by any Federal department or agency.

2) Where the prospective lower tier participant is unable to certify to any of the statements in this certification, such prospective participant shall attach an explanation to this proposal.

The undersigned makes the foregoing statements to be filed with the proposal submitted on behalf of the Offeror for contracts to be let by the Commonwealth Transportation Board.

Allyna F. Ca
Signature

02/26/2018
Date

VP OF BUSINESS ADMINISTRATION
Title

CTI CONSULTANTS, Inc.
Name of Firm

ATTACHMENT 11.8.6(b)
CERTIFICATION REGARDING DEBARMENT
LOWER TIER COVERED TRANSACTIONS

Project No.: 0081-154-733

1) The prospective lower tier participant certifies, by submission of this proposal, that neither it nor its principals is presently debarred, suspended, proposed for debarment, declared ineligible, or voluntarily excluded from participation in this transaction by any Federal department or agency.

2) Where the prospective lower tier participant is unable to certify to any of the statements in this certification, such prospective participant shall attach an explanation to this proposal.

The undersigned makes the foregoing statements to be filed with the proposal submitted on behalf of the Offeror for contracts to be let by the Commonwealth Transportation Board.



Signature

February 27, 2018
Date

Branch Manager
Title

Froehling & Robertson, Inc.
Name of Firm

ATTACHMENT 11.8.6(b)
CERTIFICATION REGARDING DEBARMENT
LOWER TIER COVERED TRANSACTIONS

Project No.: 0081-154-733

1) The prospective lower tier participant certifies, by submission of this proposal, that neither it nor its principals is presently debarred, suspended, proposed for debarment, declared ineligible, or voluntarily excluded from participation in this transaction by any Federal department or agency.

2) Where the prospective lower tier participant is unable to certify to any of the statements in this certification, such prospective participant shall attach an explanation to this proposal.

The undersigned makes the foregoing statements to be filed with the proposal submitted on behalf of the Offeror for contracts to be let by the Commonwealth Transportation Board.



Signature

23 February 2018

Date

Senior Vice President

Title

Haley & Aldrich, Inc.

Name of Firm

ATTACHMENT 11.8.6(b)
CERTIFICATION REGARDING DEBARMENT
LOWER TIER COVERED TRANSACTIONS

Project No.: 0081-154-733

- 1) The prospective lower tier participant certifies, by submission of this proposal, that neither it nor its principals is presently debarred, suspended, proposed for debarment, declared ineligible, or voluntarily excluded from participation in this transaction by any Federal department or agency.

- 2) Where the prospective lower tier participant is unable to certify to any of the statements in this certification, such prospective participant shall attach an explanation to this proposal.

The undersigned makes the foregoing statements to be filed with the proposal submitted on behalf of the Offeror for contracts to be let by the Commonwealth Transportation Board.

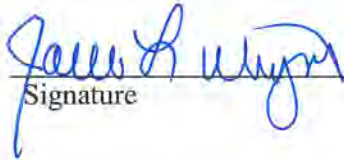

Signature

2/27/18
Date

Partner
Title

Pulsar Advertising, Inc.
Name of Firm

ATTACHMENT 11.8.6(b)
CERTIFICATION REGARDING DEBARMENT
LOWER TIER COVERED TRANSACTIONS

Project No.: 0081-154-733

1) The prospective lower tier participant certifies, by submission of this proposal, that neither it nor its principals is presently debarred, suspended, proposed for debarment, declared ineligible, or voluntarily excluded from participation in this transaction by any Federal department or agency.

2) Where the prospective lower tier participant is unable to certify to any of the statements in this certification, such prospective participant shall attach an explanation to this proposal.

The undersigned makes the foregoing statements to be filed with the proposal submitted on behalf of the Offeror for contracts to be let by the Commonwealth Transportation Board.



Signature

February 26, 2018

Date

Managing Member

Title

Traffic Signals Plus, PLLC

Name of Firm

VOLUME 2

Copy 02 of 10 Copies



DESIGN CONCEPT PLANS

I-81 Bridge Replacement at Exit 114

A Design-Build Project

State Project No.: 0081-154-733, R201, C501, B601, B616

Federal Project No.: NHPP-081-2(992)

Contract ID Number: C00093074DB96

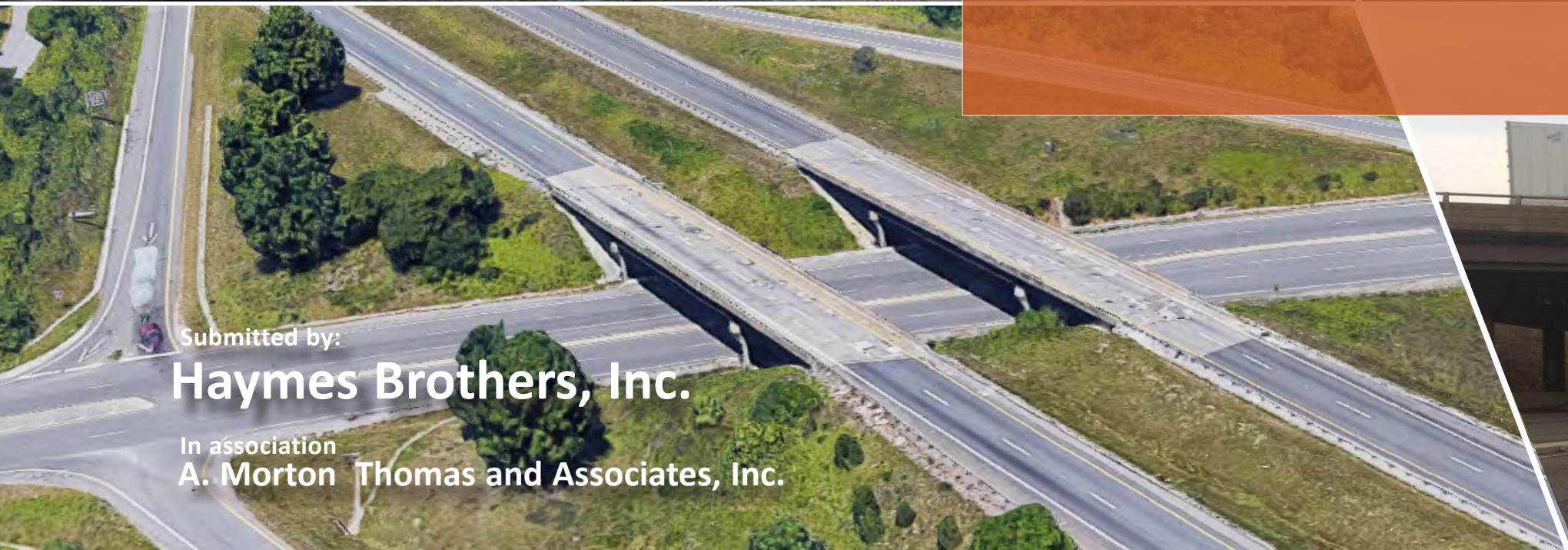

Submitted by:
Haymes Brothers, Inc.

In association
A. Morton Thomas and Associates, Inc.



TEMPORARY NB DETOUR AND TYPICAL SECTIONS

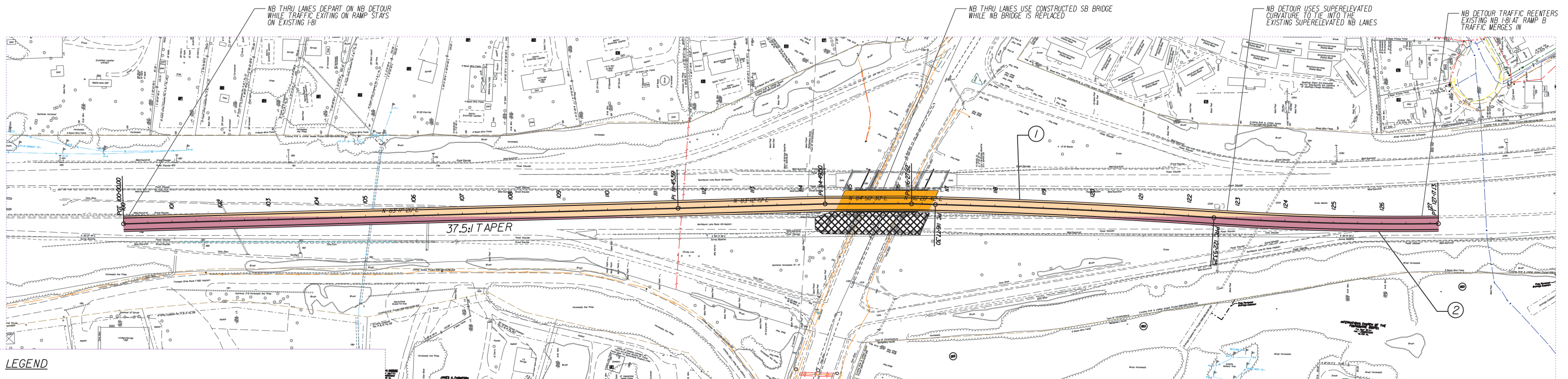
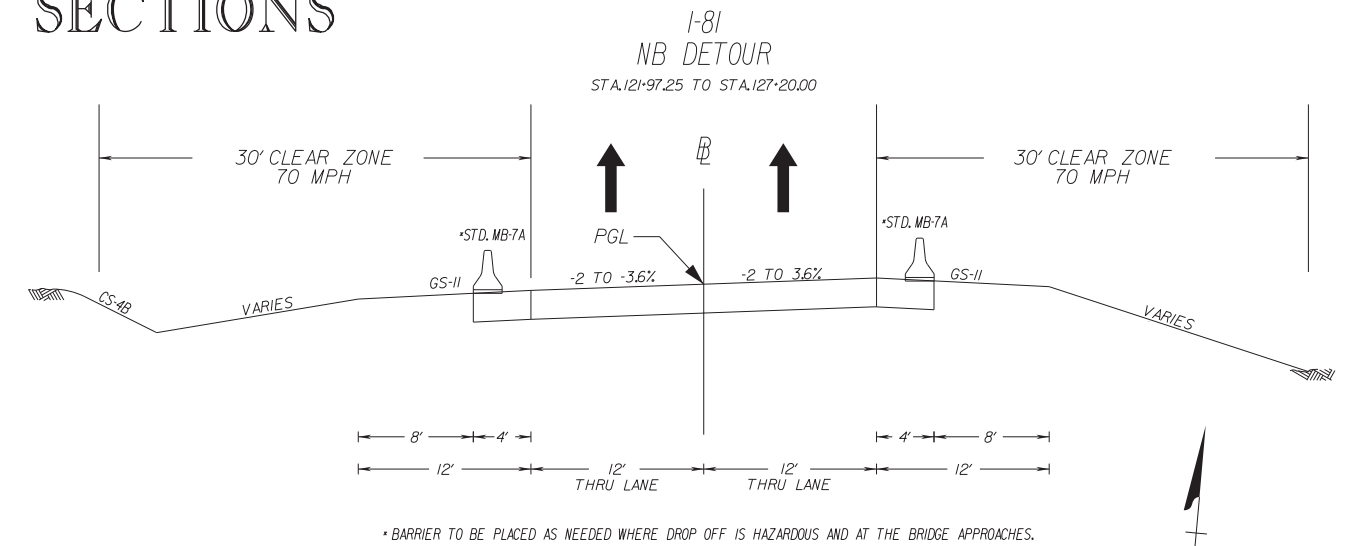
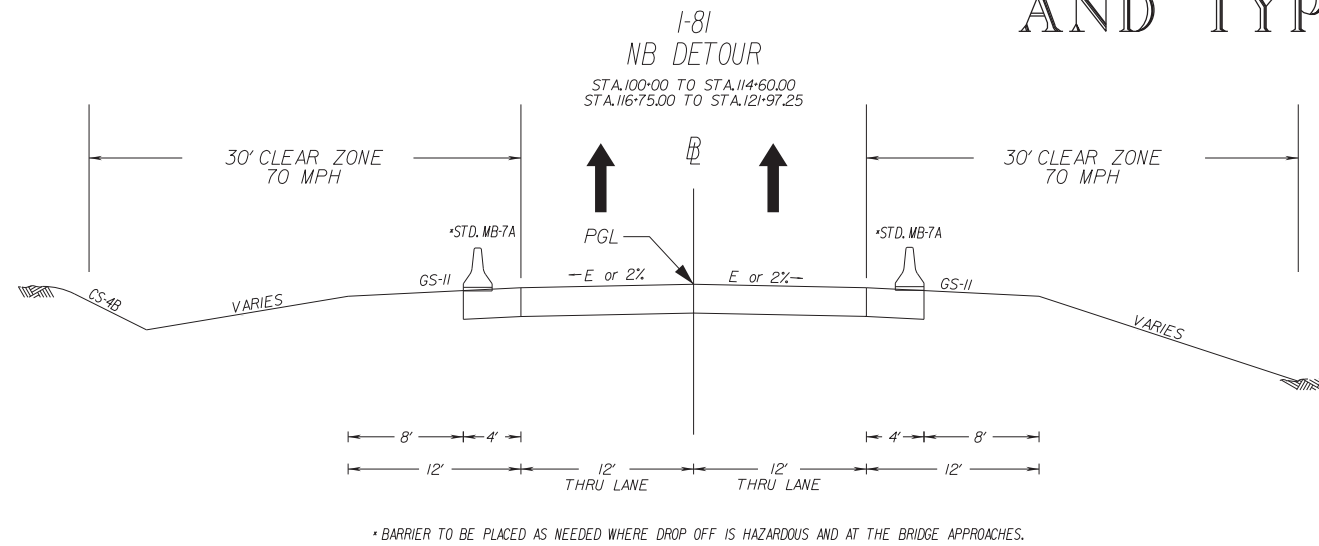

LEGEND

- FULL DEPTH PAVEMENT
- MILL AND OVERLAY
- ASPHALT BUILD-UP
- BRIDGE DECK
- PROPOSED DRAINAGE
- DEMOLITION OF PAVEMENT
- CONSTR. LIMITS IN CUTS
- CONSTR. LIMITS IN FILLS
- EXISTING RIGHT OF WAY
- EXISTING WETLANDS
- EXISTING FIBER/COMM. LINE
- EXISTING ELECTRICAL
- EXISTING GAS
- EXISTING SANITARY
- EXISTING WATER

NB DETOUR CONST. B.L.

- ① Curve TEMP1
 PI = 119+65.31
 DELTA = 2° 16' 33.0" (RT)
 D = 0' 23' 43"
 T = 288.01'
 L = 575.95'
 R = 14,500.00'
 PRC = 116+77.30
 PRC = 122+53.25
 SE = N/A
 DS = 70 MPH
- ② Curve TEMP2
 PI = 124+85.32
 DELTA = 4° 39' 22.7" (LT)
 D = 1' 00' 14"
 T = 232.07'
 L = 463.88'
 R = 5,708.00'
 PRC = 122+53.25
 PRC = 127+17.13
 SE = 3.6%
 DS = 70 MPH

THESE PLANS ARE UNFINISHED AND UNAPPROVED AND ARE NOT TO BE USED FOR ANY TYPE OF CONSTRUCTION OR THE ACQUISITION OF RIGHT OF WAY.

PROPOSAL CONCEPT PLANS

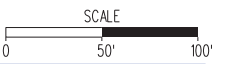

TYPICAL SECTIONS

NOTE: SEE RFP FOR PROPOSED PAVEMENT STRUCTURE

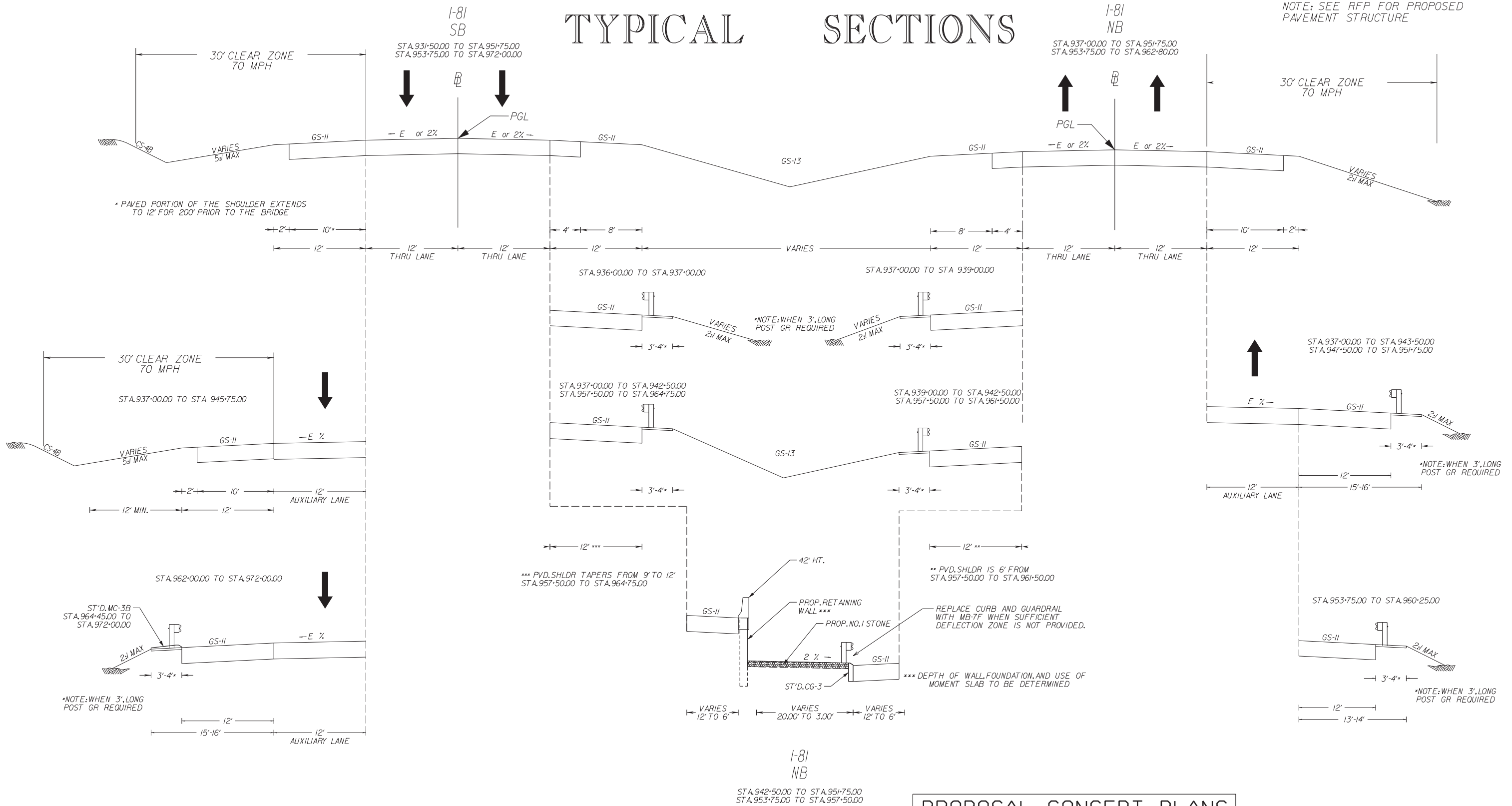

PROPOSAL CONCEPT PLANS

THESE PLANS ARE UNFINISHED AND UNAPPROVED AND ARE NOT TO BE USED FOR ANY TYPE OF CONSTRUCTION OR THE ACQUISITION OF RIGHT OF WAY.

NOT TO SCALE

E = REQUIRED SUPERELEVATION OR INCLINED PLANE CROSS SLOPE
 E SHALL EQUAL 2% PITCHED LEFT TO RIGHT FOR BOTH NB AND SB I-81 AS SHOWN ON PROFILE SHEETS

TYPICAL SECTIONS

NOT TO SCALE

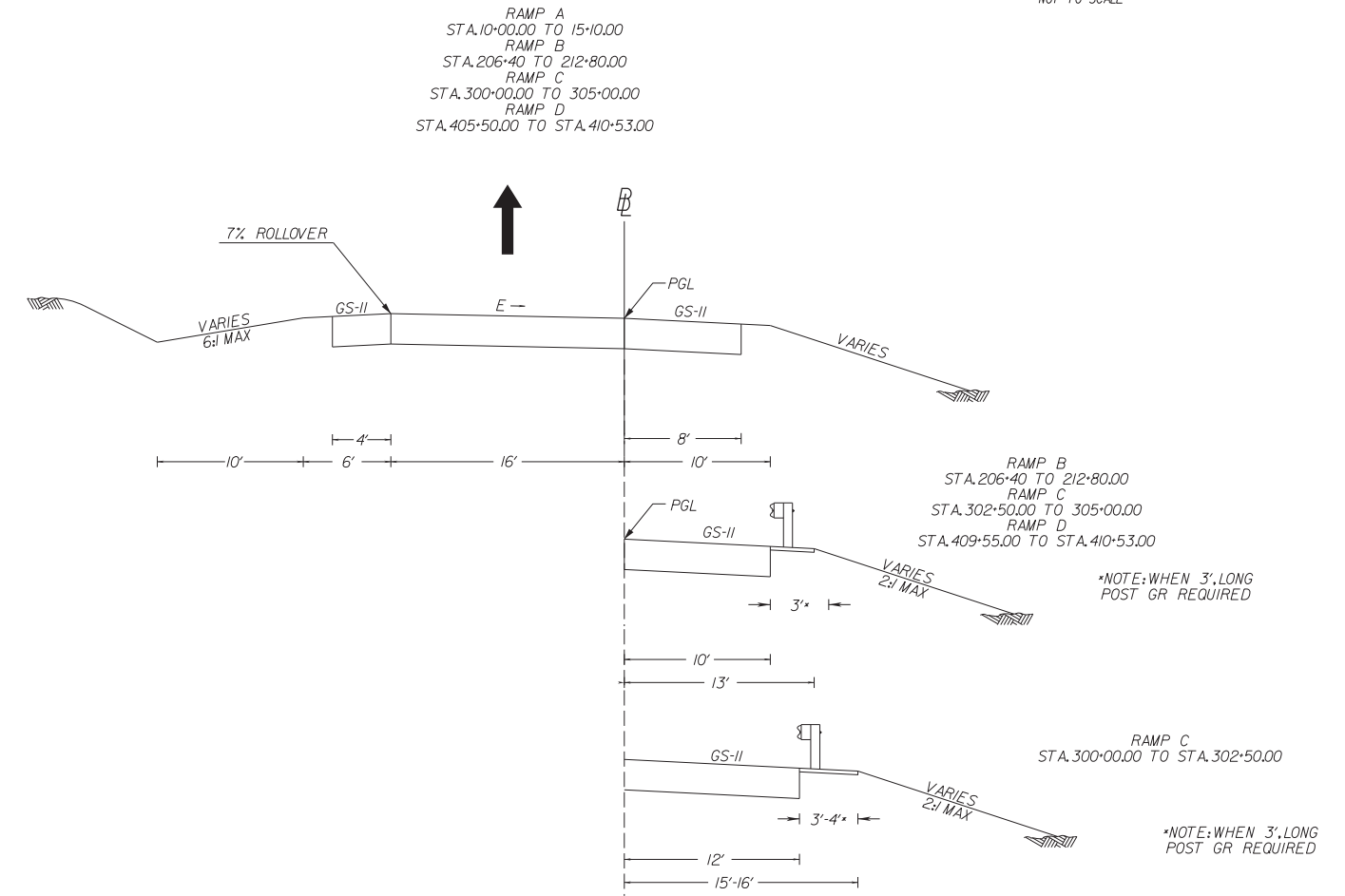
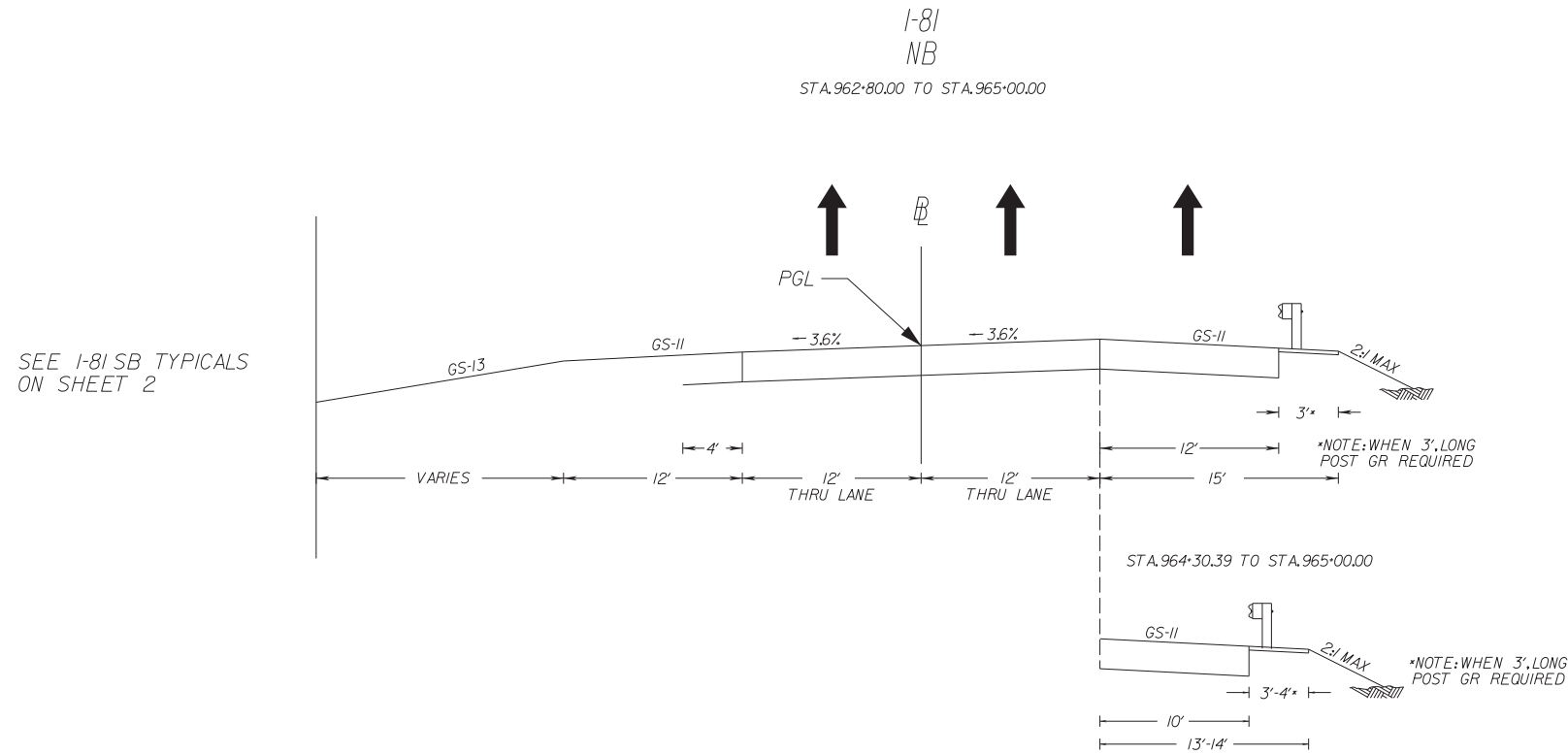

NOTE 1: BPPS-2 SHALL BE LOCATED ADJACENT TO ABUTMENT/WINGWALL AS SHOWN ON STRUCTURE CONCEPT PLAN. APPROACH END PROTECTION TO BE PROVIDED AS REQUIRED.

(BOTH SIDES)

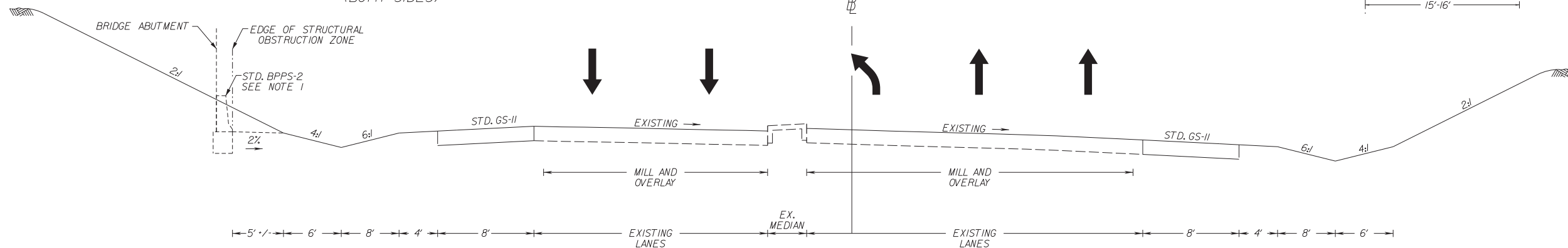

PROPOSAL CONCEPT PLANS

THESE PLANS ARE UNFINISHED AND UNAPPROVED AND ARE NOT TO BE USED FOR ANY TYPE OF CONSTRUCTION OR THE ACQUISITION OF RIGHT OF WAY.

UTILITY OWNERS

- | | |
|---|---|
| AEP
David Edwards
2255 Prospect Drive
Christiansburg, VA 24073
540-381-2512 | Comcast
Juan Rosario
560 Patton St.
Danville, VA 24541
434-791-5137 |
| Verizon
Allen Asbury
4843 Oakland Blvd NE
Roanoke, VA 24012
540-265-7574 | Citizens
Eddie Bower
220 Webbs Mill Rd.
Floyd, VA 24091
540-745-9570 |
| Lumos Networks
John Van Lew
P.O. Box 174
Daleville, VA 24083
540-591-3570 | VDOT ITS
L. Shawn Meadows
1596 Deborah Lane
Salem, VA 24153
Larry.Meadows@VDOT.Virginia.gov
(540) 375-0154 |

Town Of Christiansburg (Water And Sewer)
 Wayne Nelson
 100 East Main Street
 Christiansburg, VA 24073
 (540) 382-6120

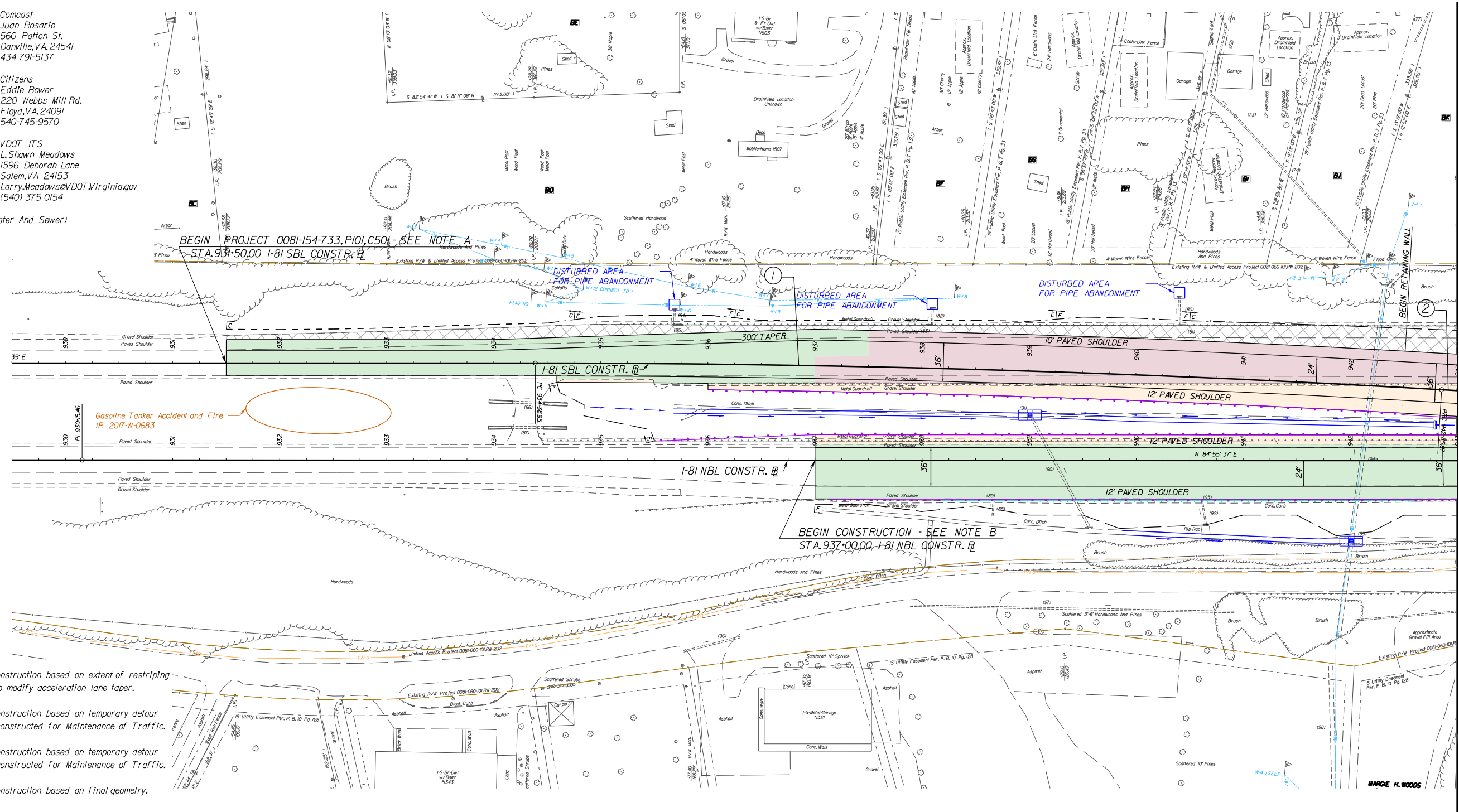

- Notes:
- Limit of Construction based on extent of restriping required to modify acceleration lane taper.
 - Limit of Construction based on temporary detour alignment constructed for Maintenance of Traffic.
 - Limit of Construction based on temporary detour alignment constructed for Maintenance of Traffic.
 - Limit of Construction based on final geometry.

LEGEND

	FULL DEPTH PAVEMENT		DEMOLITION OF PAVEMENT		EXISTING FIBER/COMM. LINE
	MILL AND OVERLAY		CONSTR. LIMITS IN CUTS		EXISTING ELECTRICAL
	ASPHALT BUILD-UP		CONSTR. LIMITS IN FILLS		EXISTING GAS
	BRIDGE DECK		EXISTING RIGHT OF WAY		EXISTING SANITARY
	PROPOSED DRAINAGE		EXISTING WETLANDS		EXISTING WATER

I-81 SBL CONST. B.L.

1 Curve SB02
 PI = 938+62.53
 DELTA = 3° 20' 47.57" (RT)
 D = 0' 23' 43"
 L = 423.58'
 T = 846.92'
 R = 14500.00'
 PC = 934+38.95'
 PRC = 942+85.87'
 SE = 3.67'
 DS = 70 MPH

2 Curve SB03
 PI = 934+84.12
 DELTA = 9° 26' 53.22" (LT)
 D = 0' 23' 43"
 L = 198.25'
 T = 239.06'
 R = 14500.00'
 PC = 942+85.87'
 PRC = 966+76.93'
 SE = NC
 DS = 70 MPH

PROPOSAL CONCEPT PLANS

THESE PLANS ARE UNFINISHED AND UNAPPROVED AND ARE NOT TO BE USED FOR ANY TYPE OF CONSTRUCTION OR THE ACQUISITION OF RIGHT OF WAY.

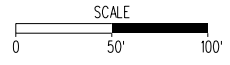

MATCHLINE SEE SHEET 4 STA. 943+00.00 I-81 NBL CONSTR. B.L.

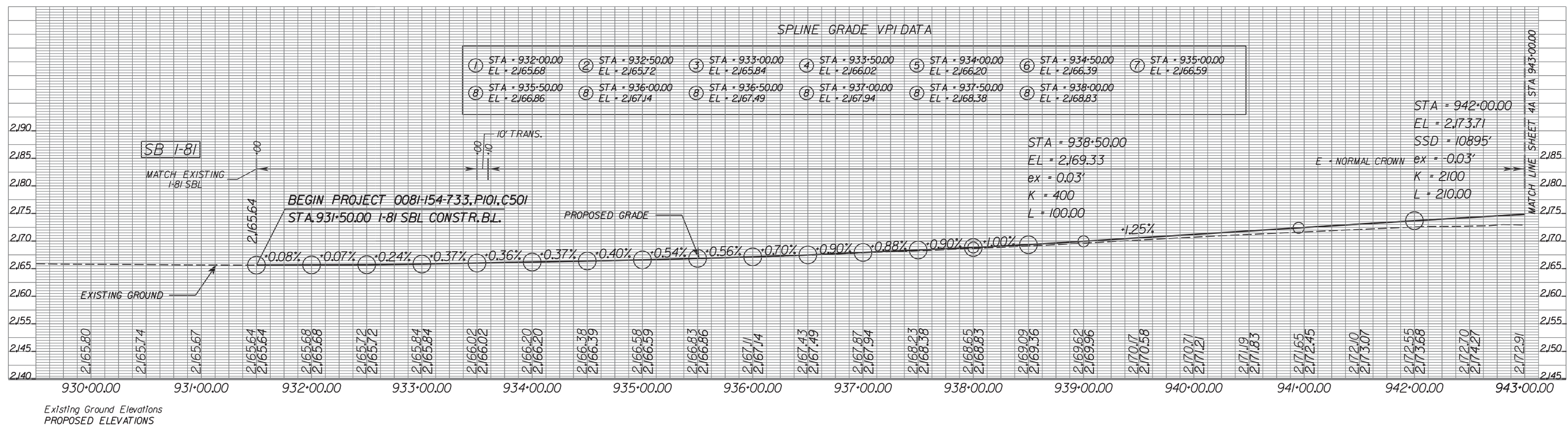
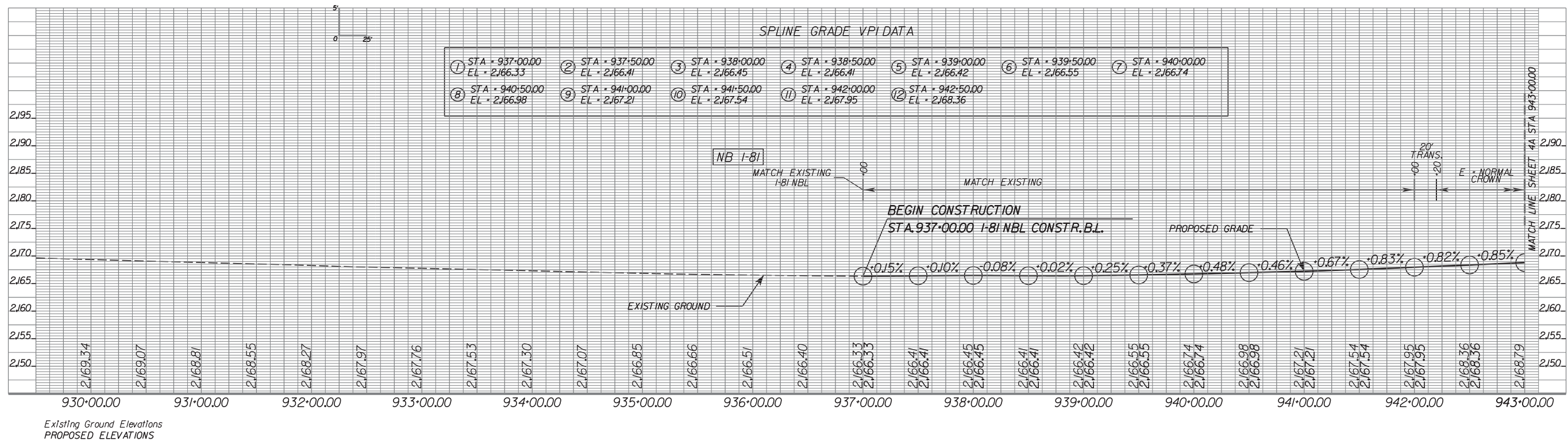

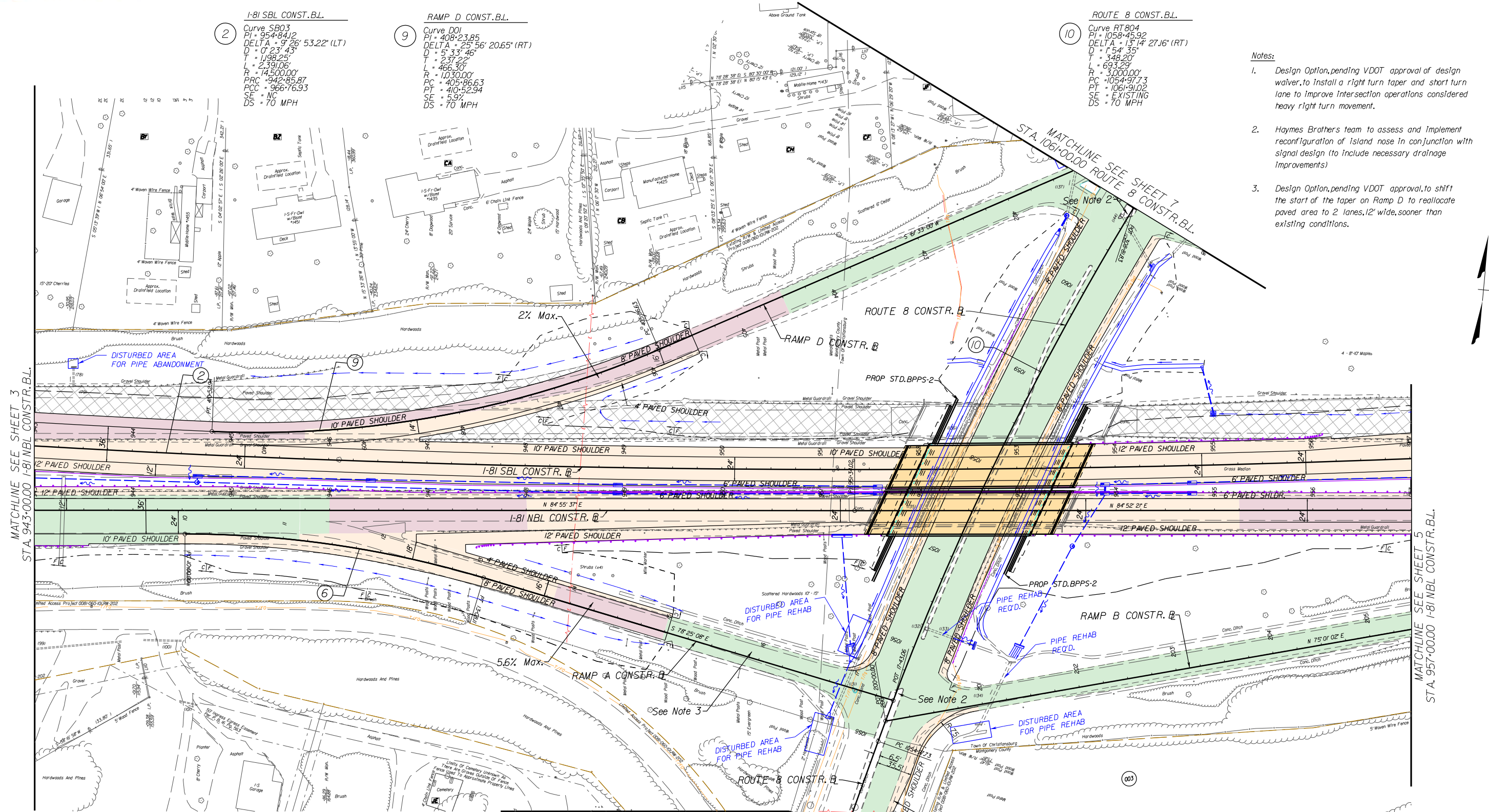

I-81 SBL CONST. B.L.
 (2) Curve SB03
 PI = 954.8412
 DELTA = 9° 26' 53.22" (LT)
 D = 0' 23' 43"
 T = 198.25'
 L = 2,391.06'
 R = 14,500.00'
 PRC = 942.85.87
 PCC = 966.76.93
 SE = NC
 DS = 70 MPH

RAMP D CONST. B.L.
 (9) Curve D01
 PI = 408.23.85
 DELTA = 25° 56' 20.65" (RT)
 D = 5' 33' 46"
 T = 237.92'
 L = 466.30'
 R = 10,300.00'
 PC = 405.86.63
 PT = 410.52.94
 SE = 5.9%
 DS = 70 MPH

ROUTE 8 CONST. B.L.
 (10) Curve RT804
 PI = 1058.45.92
 DELTA = 13° 14' 27.16" (RT)
 D = 1' 54' 35"
 T = 348.20'
 L = 693.29'
 R = 3,000.00'
 PC = 1054.97.73
 PT = 1061.91.02
 SE = EXISTING
 DS = 70 MPH

RAMP A CONST. B.L.
 (6) Curve A01
 PI = 1155.15
 DELTA = 16° 39' 14.64" (RT)
 D = 5' 24' 19"
 T = 155.15'
 L = 308.11'
 R = 1,060.00'
 PC = 1100.00
 PT = 1130.81
 SE = NC
 DS = 70 MPH

- Notes:**
- Design Option, pending VDOT approval of design waiver, to install a right turn taper and short turn lane to improve intersection operations considered heavy right turn movement.
 - Haymes Brothers team to assess and implement reconfiguration of island nose in conjunction with signal design (to include necessary drainage improvements)
 - Design Option, pending VDOT approval, to shift the start of the taper on Ramp D to reallocate paved area to 2 lanes, 12' wide, sooner than existing conditions.

LEGEND

	FULL DEPTH PAVEMENT		DEMOLITION OF PAVEMENT		EXISTING FIBER/COMM. LINE
	MILL AND OVERLAY		CONSTR. LIMITS IN CUTS		EXISTING ELECTRICAL
	ASPHALT BUILD-UP		CONSTR. LIMITS IN FILLS		EXISTING GAS
	BRIDGE DECK		EXISTING RIGHT OF WAY		EXISTING SANITARY
	PROPOSED DRAINAGE		EXISTING WETLANDS		EXISTING WATER

THESE PLANS ARE UNFINISHED AND UNAPPROVED AND ARE NOT TO BE USED FOR ANY TYPE OF CONSTRUCTION OR THE ACQUISITION OF RIGHT OF WAY.

PROPOSAL CONCEPT PLANS

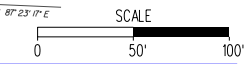

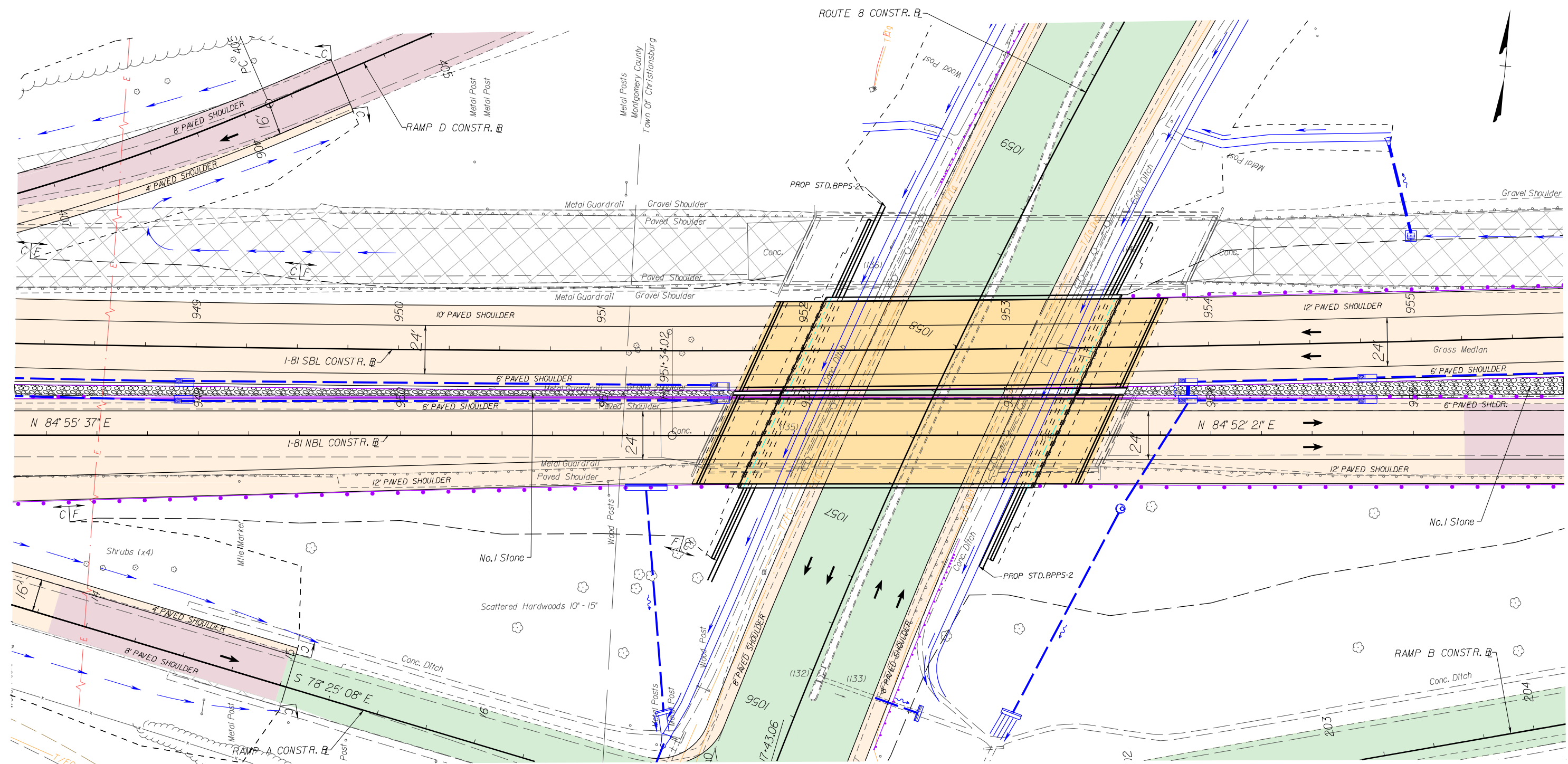

BRIDGE AREA ENLARGEMENT PLAN

THESE PLANS ARE UNFINISHED AND UNAPPROVED AND ARE NOT TO BE USED FOR ANY TYPE OF CONSTRUCTION OR THE ACQUISITION OF RIGHT OF WAY.

PROPOSAL CONCEPT PLANS

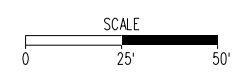

Sheet 4(1)

Page | 49

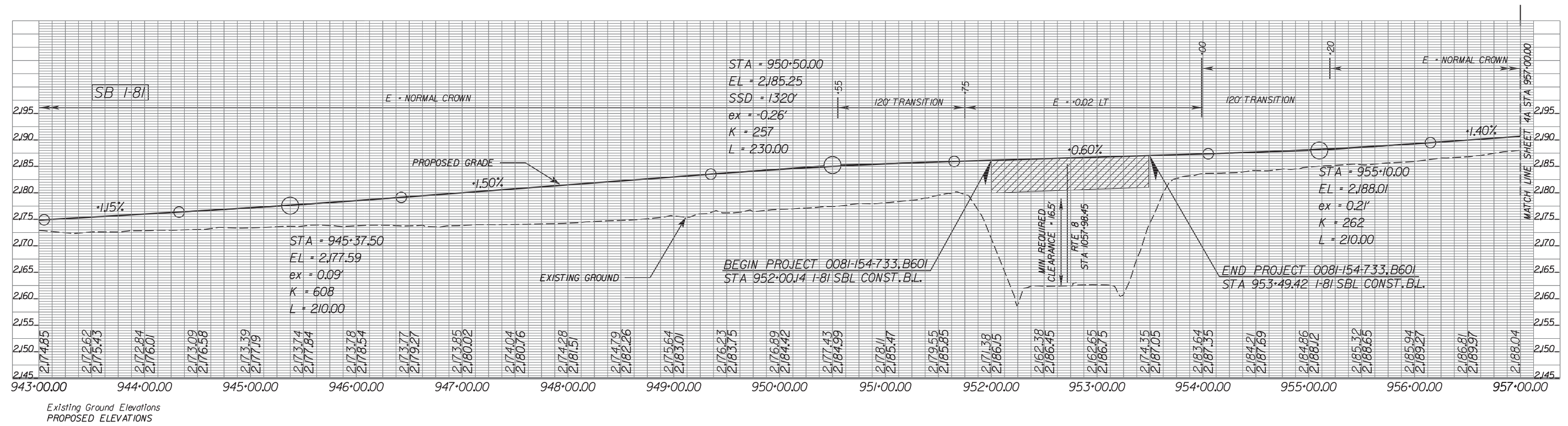
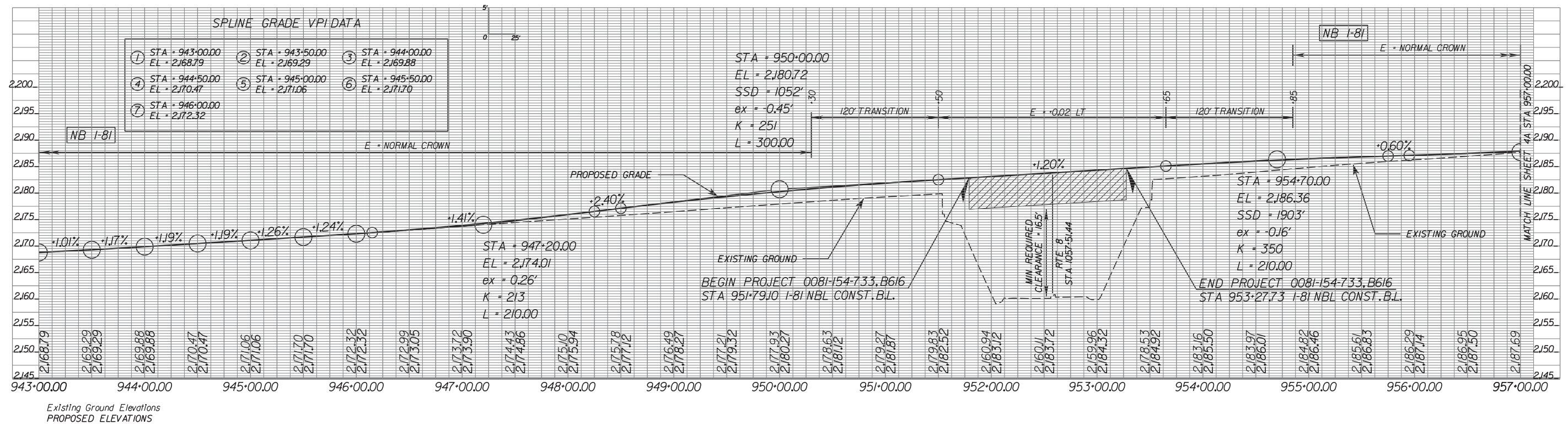

RAMP C CONST.B.L.		I-81 SBL CONST.B.L.	
8	Curve CO1 PI = 302.0915 DELTA = 22°57' 23.8" (RT) D = 5133.46' T = 209.15' L = 412.69' R = 1030.00' PC = 300.00.00 PT = 304.12.69 SE = NC DS = 70 MPH	2	Curve SB03 PI = 954.8412 DELTA = 9°26' 53.22" (LT) D = 0' 23' 43" T = 1198.25' L = 2.39106' R = 14500.00' PRC = 942.85.87 PCC = 966.76.93 SE = NC DS = 70 MPH
		3	Curve SB04 PI = 970.6552 DELTA = 7°40' 54.07" (LT) D = 0' 59' 2.4" T = 388.58' L = 776.00' R = 5788.00' PCC = 966.76.93 PCC = 974.52.94 SE = 3.2% DS = 70 MPH

- Notes:
- A. Limit of Construction based on extent of restriping required to modify acceleration lane taper.
 - B. Limit of Construction based on temporary detour alignment constructed for Maintenance of Traffic.
 - C. Limit of Construction based on temporary detour alignment constructed for Maintenance of Traffic.
 - D. Limit of Construction based on final geometry.

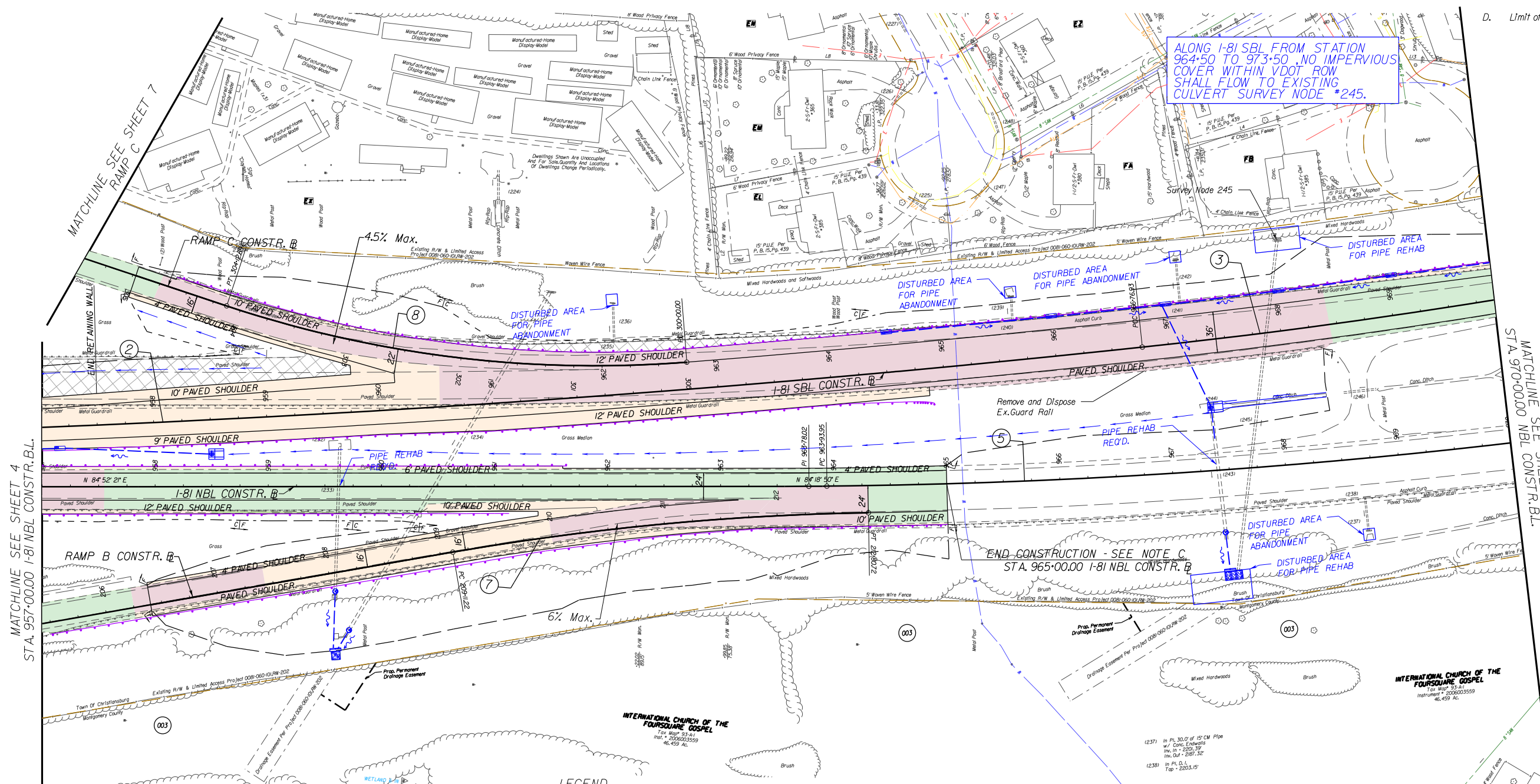

ALONG I-81 SBL FROM STATION 964.50 TO 973.50, NO IMPERVIOUS COVER WITHIN VDOT ROW SHALL FLOW TO EXISTING CULVERT SURVEY NODE #245.

MATCHLINE SEE SHEET 4
STA. 957+00.00 I-81 NBL CONST.R.B.L.

MATCHLINE SEE SHEET 6
STA. 970+00.00 NBL CONST.R.B.L.

I-81 NBL CONST.B.L.	
5	Curve NB02 PI = 972.4379 DELTA = 16°52' 25.79" (LT) D = 1'00' 00" T = 849.84' L = 1687.38' R = 5729.58' PC = 963.93.95 PT = 980.81.33 SE = NC DS = 70 MPH

RAMP B CONST.B.L.	
7	Curve BO1 PI = 210.9634 DELTA = 8°55' 58.20" (RT) D = 2° 25' 03" T = 185.13' L = 369.50' R = 2370.00' PC = 209+11.22 PT = 212+80.72 SE = NC DS = 70 MPH

LEGEND

- | | | |
|---------------------|------------------------|--------------------------|
| FULL DEPTH PAVEMENT | DEMOLITION OF PAVEMENT | EXISTING FIBER/COMM.LINE |
| MILL AND OVERLAY | CONSTR.LIMITS IN CUTS | EXISTING ELECTRICAL |
| ASPHALT BUILD-UP | CONSTR.LIMITS IN FILLS | EXISTING GAS |
| BRIDGE DECK | EXISTING RIGHT OF WAY | EXISTING SANITARY |
| PROPOSED DRAINAGE | EXISTING WETLANDS | EXISTING WATER |

PROPOSAL CONCEPT PLANS

THESE PLANS ARE UNFINISHED AND UNAPPROVED AND ARE NOT TO BE USED FOR ANY TYPE OF CONSTRUCTION OR THE ACQUISITION OF RIGHT OF WAY.

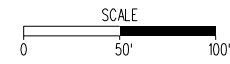

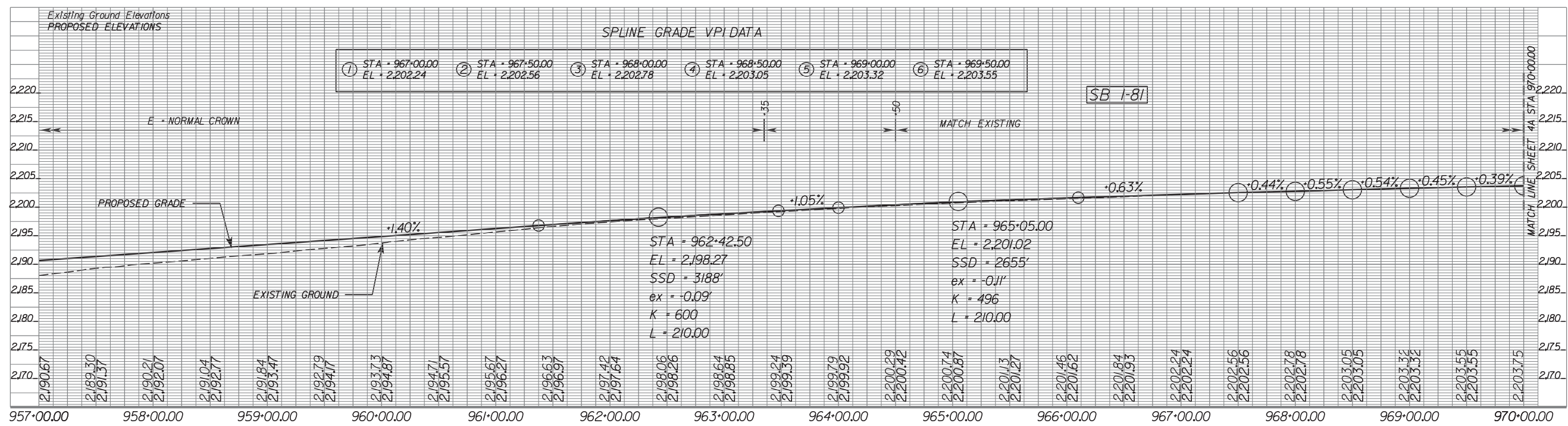
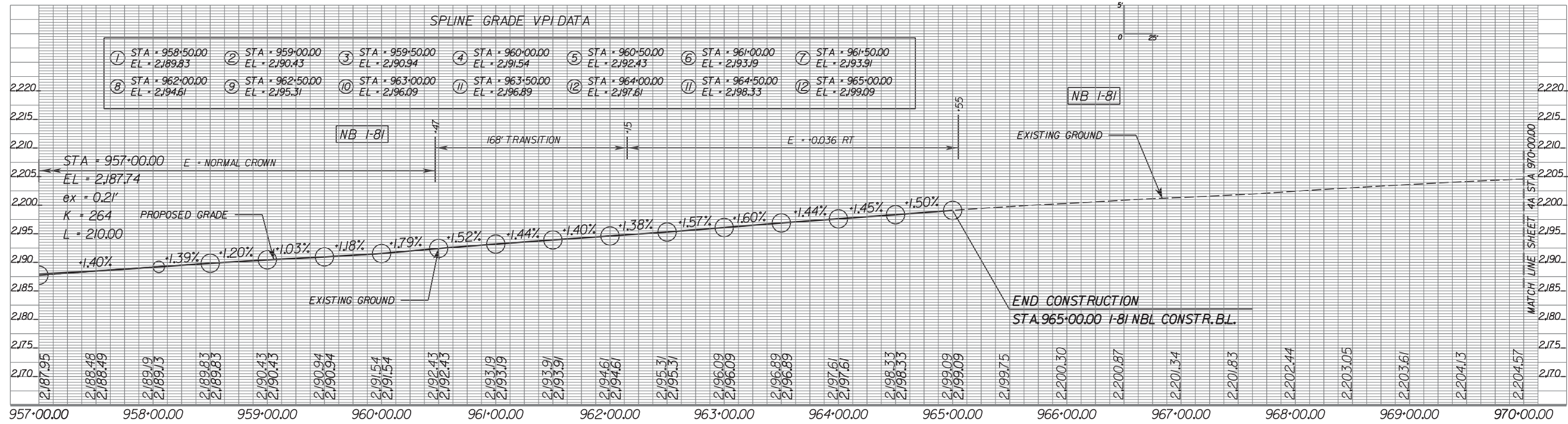

- ③ I-81 SBL CONST. B.L.
 Curve SB04
 PI = 97065.52
 DELTA = 7° 40' 54.07" (LT)
 D = 0° 59' 24"
 T = 388.58'
 L = 776.00'
 R = 5788.00'
 PCC = 966° 76.93'
 PT = 97452.94
 SE = 3.27'
 DS = 70 MPH
- ④ I-81 SBL CONST. B.L.
 Curve SB05
 PI = 97622.06
 DELTA = 2° 58' 50.95" (LT)
 D = 0° 52' 53"
 T = 169.12'
 L = 338.16'
 R = 6500.00'
 PCC = 97452.94
 PT = 97791.10
 SE = 3.27'
 DS = 70 MPH
- ⑤ I-81 NBL CONST. B.L.
 Curve NB02
 PI = 97243.79
 DELTA = 16° 52' 25.79" (LT)
 D = 1° 00' 00"
 T = 849.84'
 L = 1687.38'
 R = 5729.58'
 PCC = 963° 93.95'
 PT = 98081.33
 SE = 1.10'
 DS = 70 MPH

- Notes:
- A. Limit of Construction based on extent of restriping required to modify acceleration lane taper.
 - B. Limit of Construction based on temporary detour alignment constructed for Maintenance of Traffic.
 - C. Limit of Construction based on temporary detour alignment constructed for Maintenance of Traffic.
 - D. Limit of Construction based on final geometry.

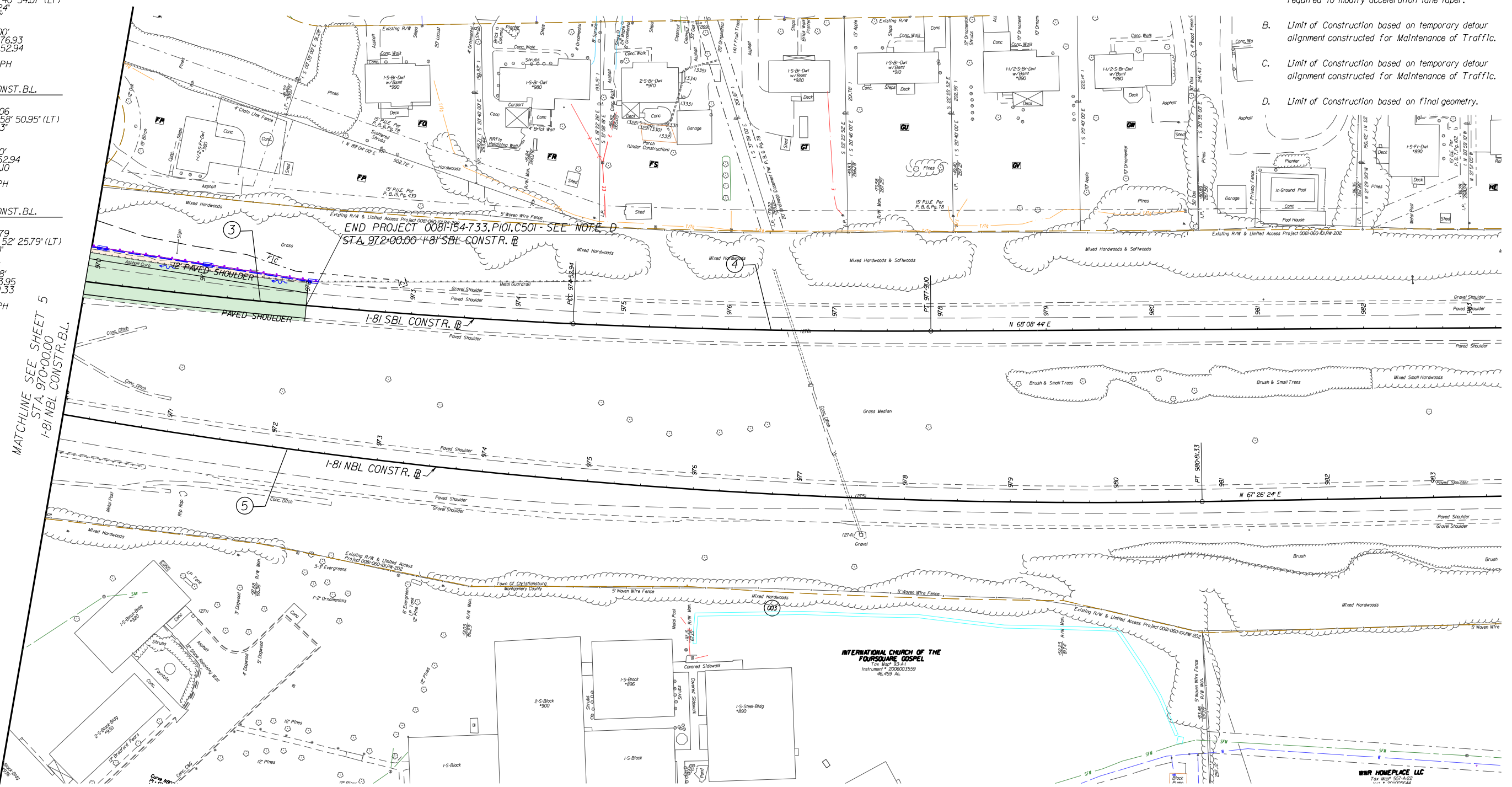

LEGEND

	FULL DEPTH PAVEMENT		DEMOLITION OF PAVEMENT		EXISTING FIBER/COMM. LINE
	MILL AND OVERLAY		CONSTR. LIMITS IN CUTS		EXISTING ELECTRICAL
	ASPHALT BUILD-UP		CONSTR. LIMITS IN FILLS		EXISTING GAS
	BRIDGE DECK		EXISTING RIGHT OF WAY		EXISTING SANITARY
	PROPOSED DRAINAGE		EXISTING WETLANDS		EXISTING WATER

PROPOSAL CONCEPT PLANS

THESE PLANS ARE UNFINISHED AND UNAPPROVED AND ARE NOT TO BE USED FOR ANY TYPE OF CONSTRUCTION OR THE ACQUISITION OF RIGHT OF WAY.



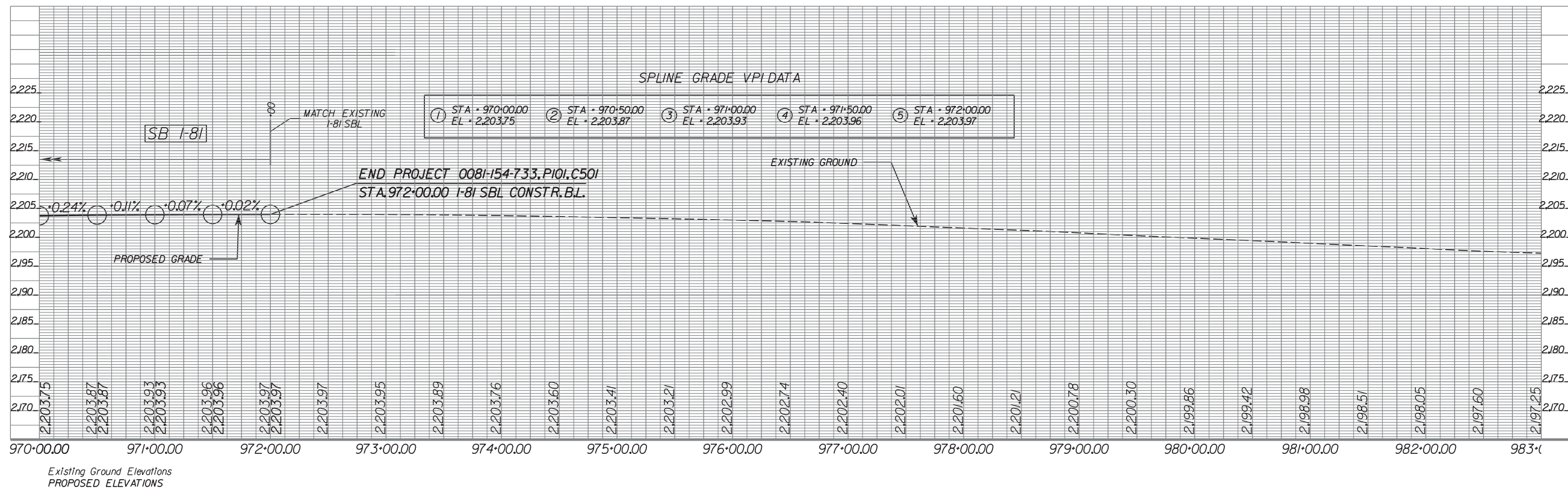
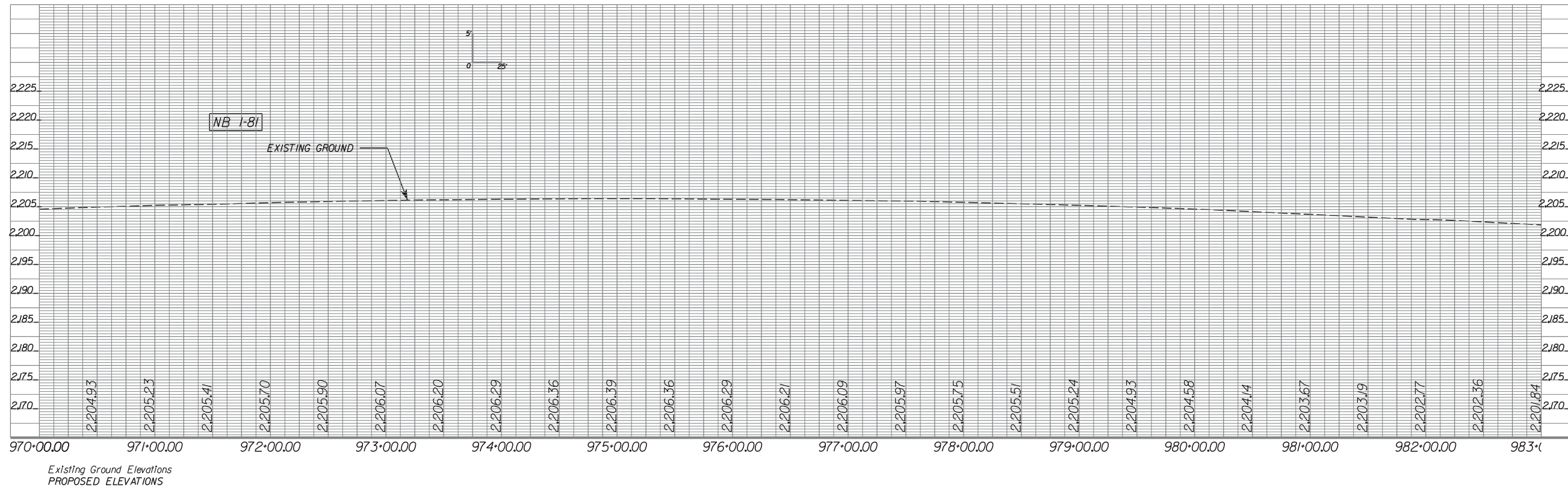

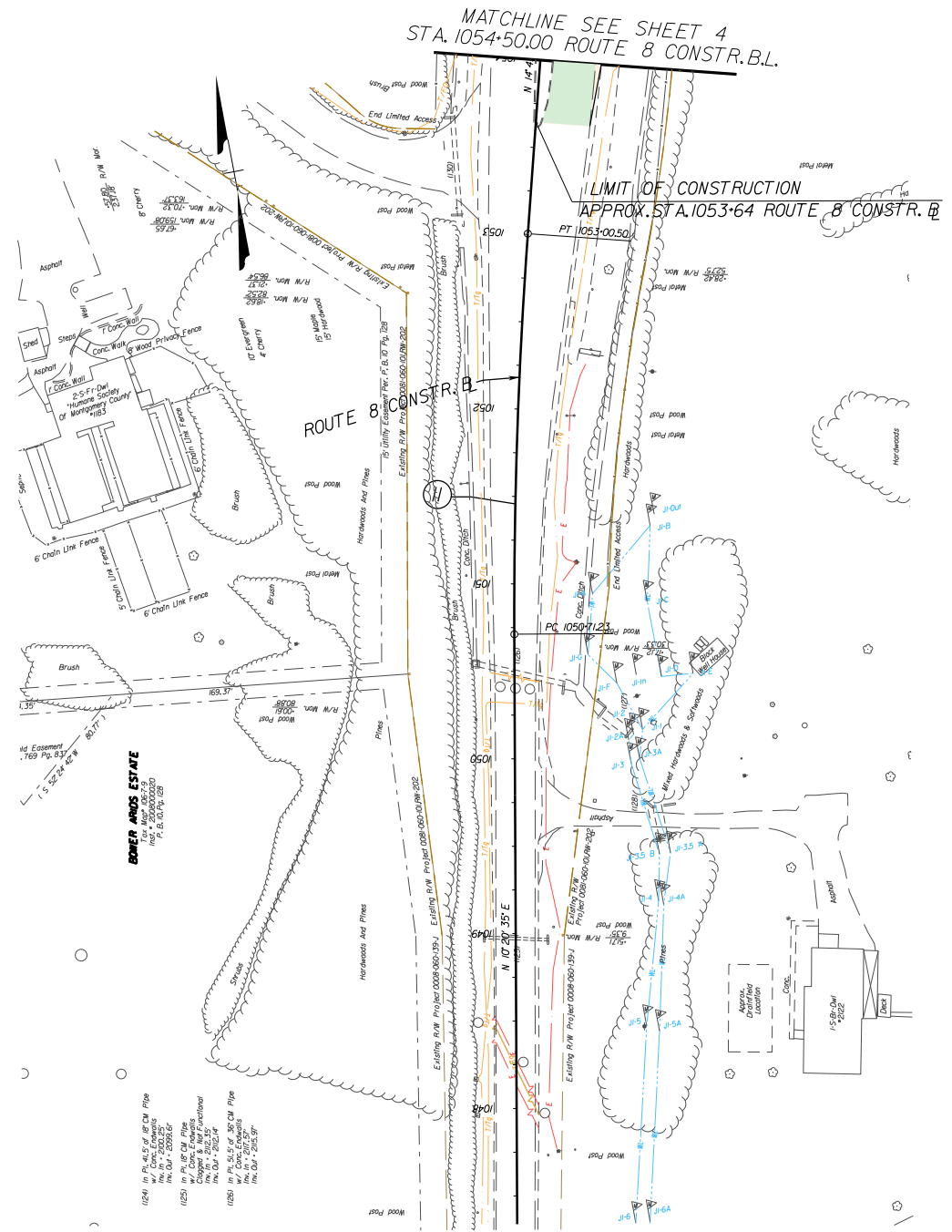

ROUTE 8 CONST.B.L.

⑩ Curve RT 804
 PI = 1058+45.92
 DELTA = 13°14' 27.16" (RT)
 D = 1°54' 35"
 T = 348.20'
 L = 693.29'
 R = 3,000.00'
 PC = 1054+97.73
 PT = 1061+91.02
 SE = EXISTING
 DS = 70 MPH

ROUTE 8 CONST.B.L.

⑪ Curve RT 803
 PI = 1051+85.92
 DELTA = 4°22' 43.17" (RT)
 D = 1°54' 35"
 T = 114.69'
 L = 229.27'
 R = 3,000.00'
 PRC = 1050+71.23
 PT = 1053+00.50
 SE = EXISTING
 DS = 70 MPH

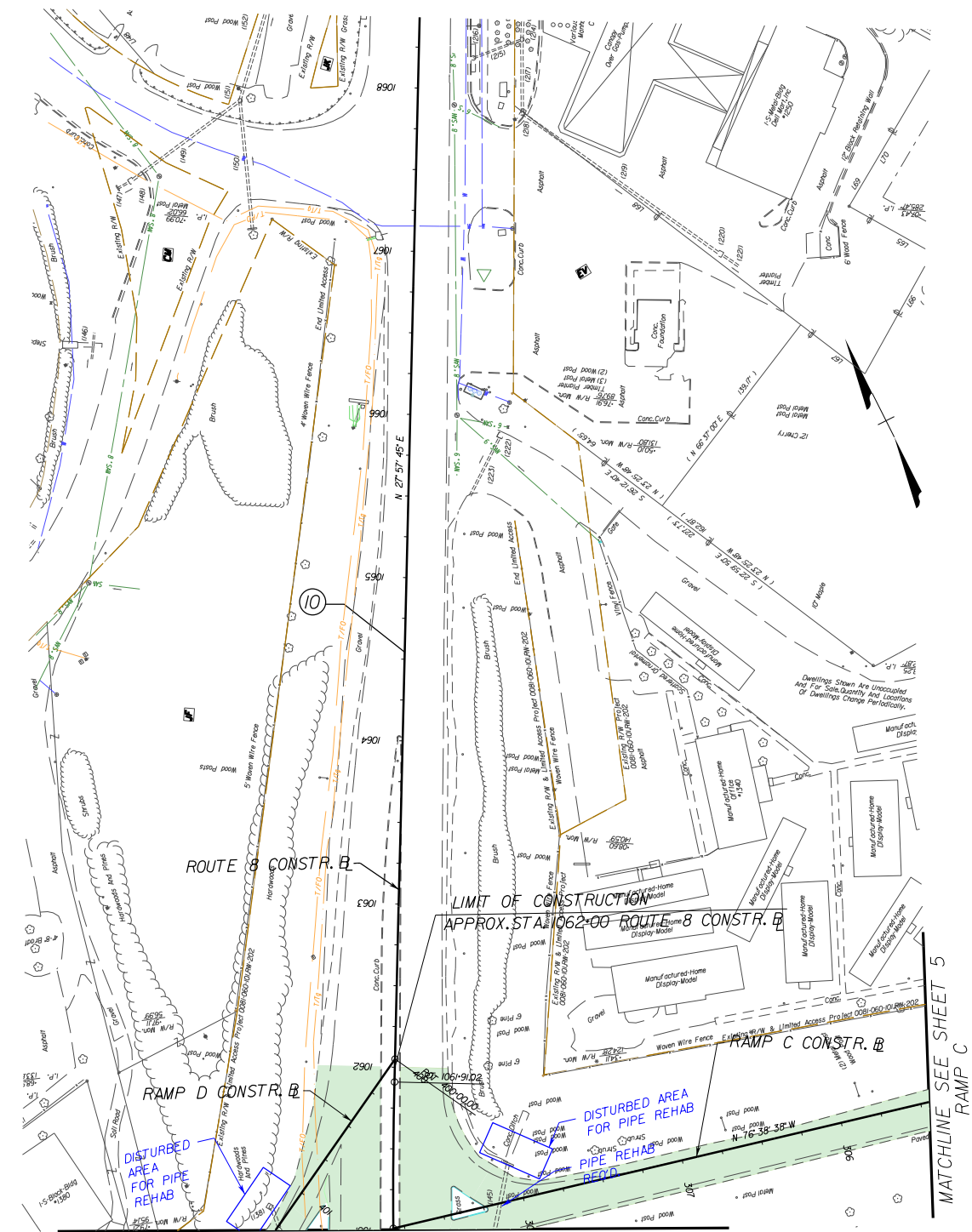

LEGEND

	FULL DEPTH PAVEMENT		DEMOLITION OF PAVEMENT		EXISTING FIBER/COMM.LINE
	MILL AND OVERLAY		CONSTR.LIMITS IN CUTS		EXISTING ELECTRICAL
	ASPHALT BUILD-UP		CONSTR.LIMITS IN FILLS		EXISTING GAS
	BRIDGE DECK		EXISTING RIGHT OF WAY		EXISTING SANITARY
	PROPOSED DRAINAGE		EXISTING WETLANDS		EXISTING WATER

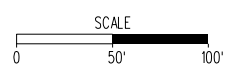

PROPOSAL CONCEPT PLANS

THESE PLANS ARE UNFINISHED AND UNAPPROVED AND ARE NOT TO BE USED FOR ANY TYPE OF CONSTRUCTION OR THE ACQUISITION OF RIGHT OF WAY.

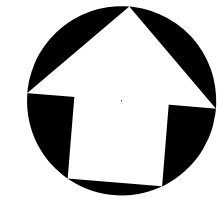

I-81 SBL CONST. BL
 Curve SB03
 PI = 954+84.12
 DELTA = 9° 26' 53.22" (LT)
 D = 0° 23' 43"
 T = 1,198.25'
 L = 2,391.06'
 R = 14,500.00'

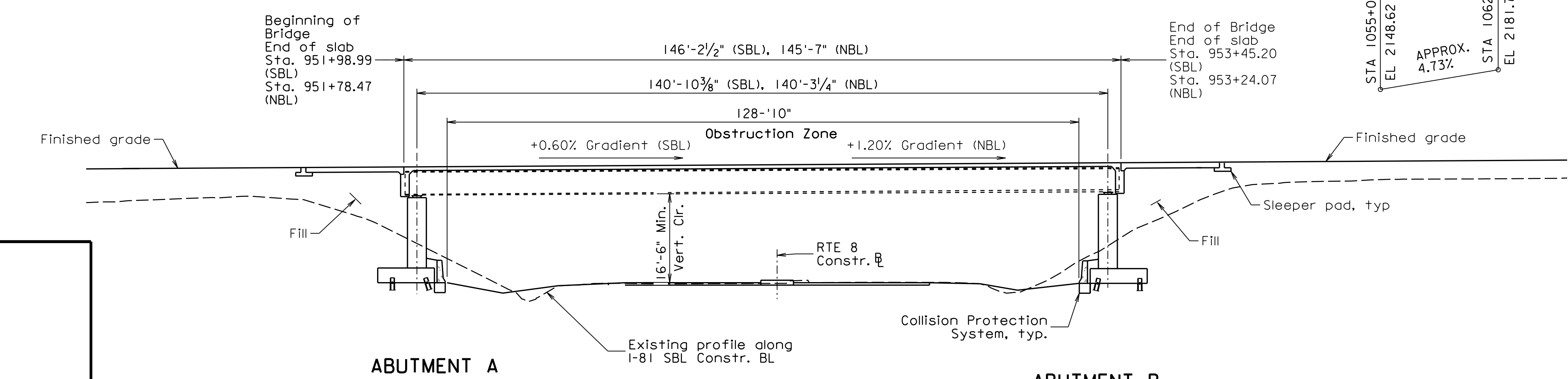
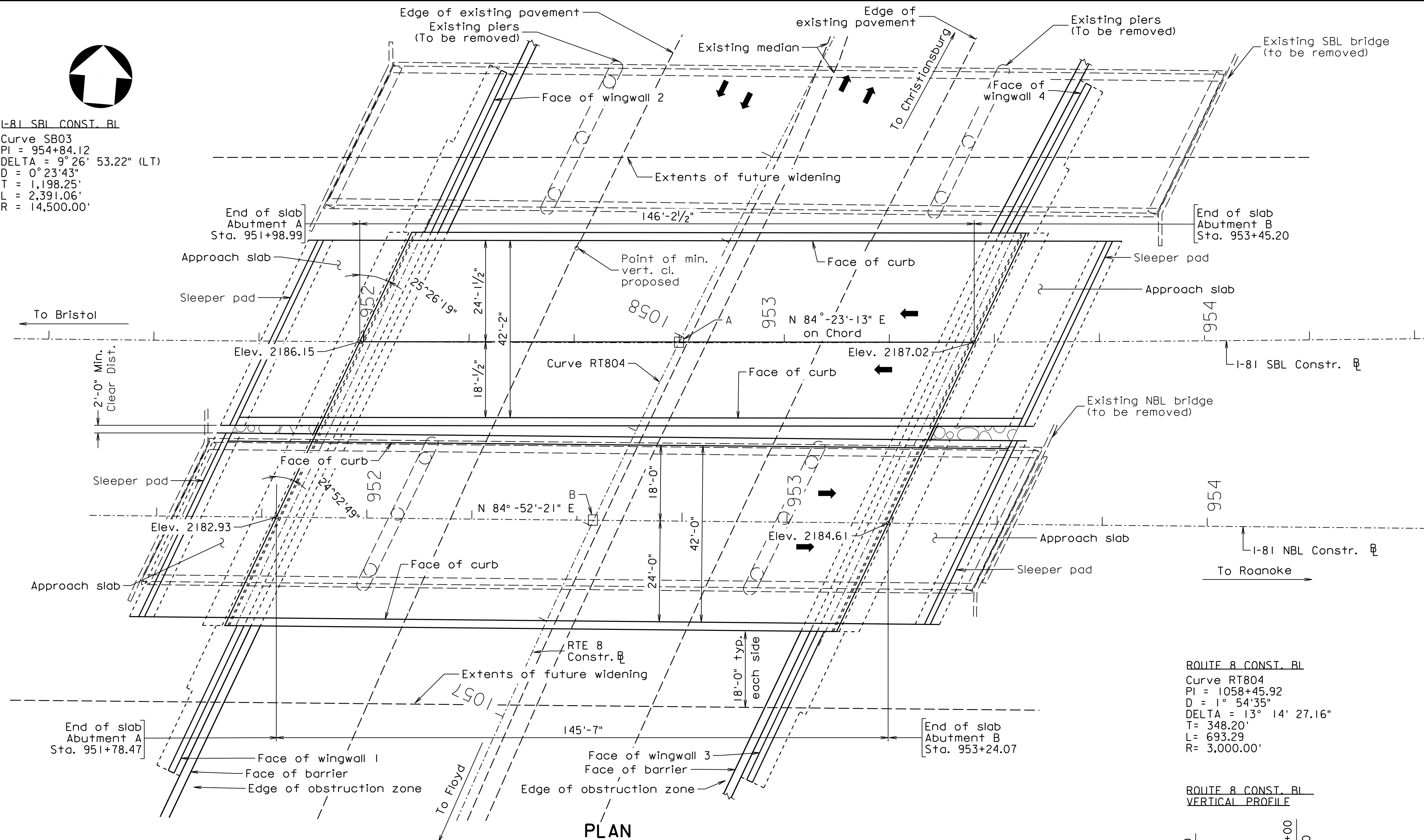

STATE	FEDERAL AID	ROUTE	PROJECT	ROUTE	STATE	PROJECT	SHEET NO.
VA.	NHPP-081-2(992)	81	0081-154-733,B601, B616	81	0081-154-733,B601, B616		1
NBIS Number: 00000000030366 NBL 00000000030365 SBL			UPC No. 93074			FHWA Construction and Scour Code: X271-SN	
Federal Oversight Code: NFO							

DESIGN EXCEPTION(S):

None

GENERAL NOTES:

- Width: 42'-0" (NBL), 42'-2" (SBL) face-to-face of parapets
- Span layout: Span layout: 145'-7" single steel plate girder span, (NBL), and 146'-2 1/2" single steel plate girder span, (SBL)
- Capacity: HL-93 loading.
- Specifications:
 - Construction: Virginia Department of Transportation Road and Bridge Specifications, 2016.
 - Design: AASHTO LRFD Bridge Design Specifications, 7th Edition, 2014; and VDOT Modifications.
 - Standards: Virginia Department of Transportation Road and Bridge Standards, 2016 and all current revisions.

These plans are incomplete unless accompanied by the Supplemental Specifications and Special Provisions included in the contract documents.

Design Loading includes 20 psf allowance for construction tolerances and construction methods.

Design Loading includes 15 psf allowance for future wearing surface.

All structural steel, including bearing, shall be ASTM A709 Grade 50W and shall be unpainted.

Bridge No. of existing bridges is 2000 and 2001. Plan No. is 169-15.

The existing structure is designated a Type B Structure in accordance with Sec. 411.

- Tie stations:
- A Sta. 952+74.40 I-81 SBL Constr. BL
Sta. 1057+93.67 Route 8 Constr. BL
Δ = 63° 51' -47"
 - B Sta. 952+53.95 I-81 NBL Constr. BL
Sta. 1057+51.45 Route 8 Constr. BL
Δ = 64° 44' -03"

PRELIMINARY PLANS
 THESE PLANS NOT TO BE USED
 FOR CONSTRUCTION



COMMONWEALTH OF VIRGINIA
 DEPARTMENT OF TRANSPORTATION
 PROPOSED BRIDGE REPLACEMENTS ON
 I-81 OVER ROUTE 8 (W. MAIN STREET)
 MONTGOMERY CO. / TOWN OF CHRISTIANSBURG
 - 0.36 MI. E. OF INT. ROUTE 8
 PROJ. 0081-154-733, B601, B616

Recommended for Approval: _____	Developer's Designee _____	Date _____
Approved: _____	Chief Engineer _____	XXXXX Date _____

Date: Feb. 2018 © 2014, Commonwealth of Virginia Sheet 1 of 5

\$FILES\$

AMT, INC. ROCKVILLE, MD STRUCTURAL ENGINEER	
PLANS BY:	AMT, INC.
COORDINATED:	--
SUPERVISED:	Khosrow Babaei
DESIGNED:	Matt Waskiewicz
DRAWN:	Zhipeng Guo
CHECKED:	Hongting Zhao

No.	Description	Date
REVISIONS		
For Table of Revisions, see Sheet -.		

Scale: 1" = 20'

STATE	FEDERAL AID		STATE	SHEET
ROUTE	PROJECT	ROUTE	PROJECT	NO.
VA.	NHPP-081-2(992)	I-81	0081-154-733, B601, B616	2

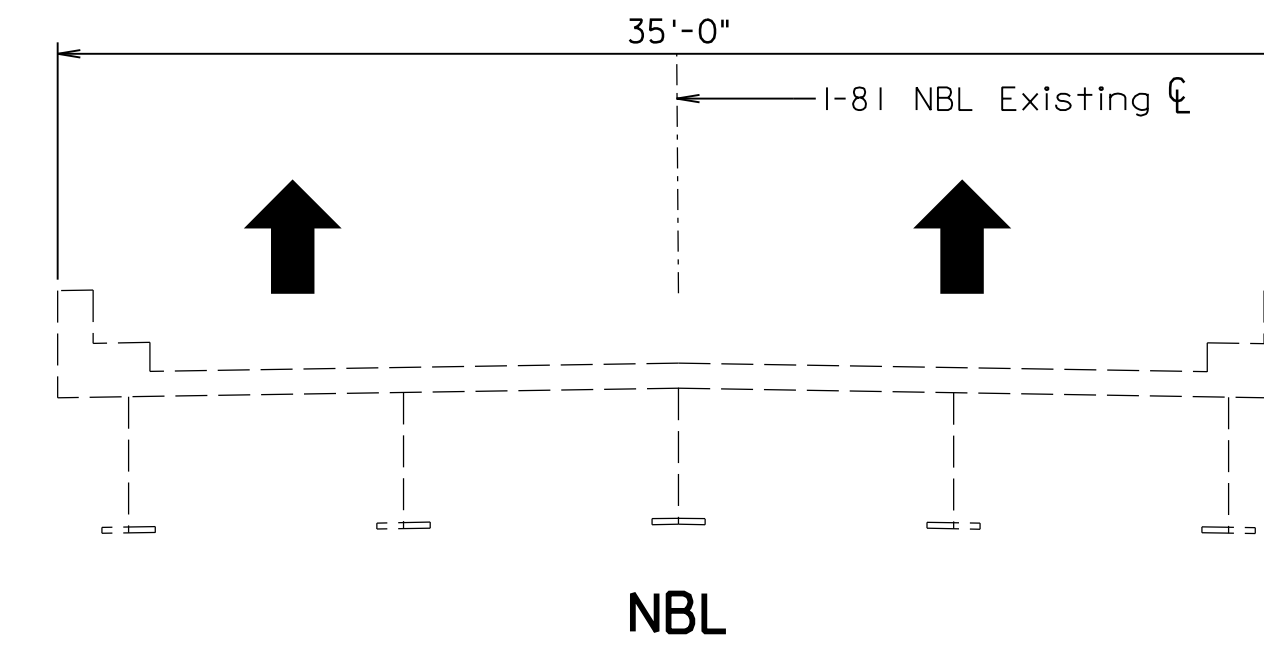
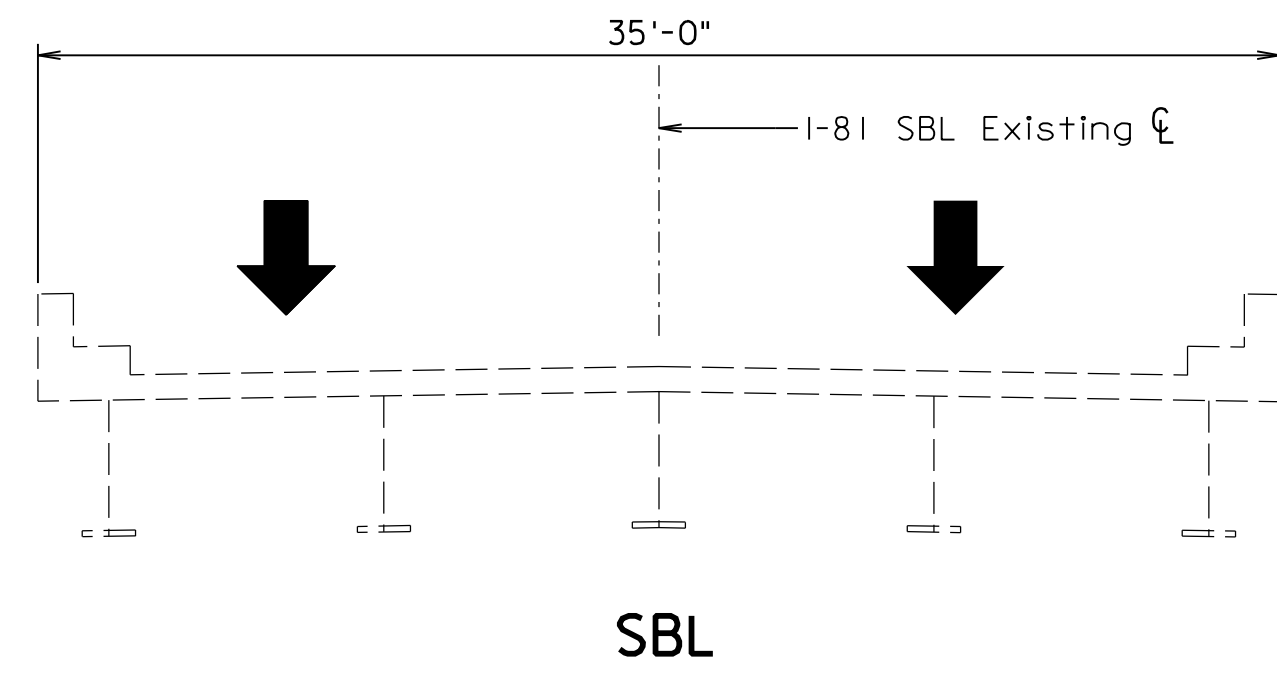

EXISTING CONDITION
(Looking Upstation)

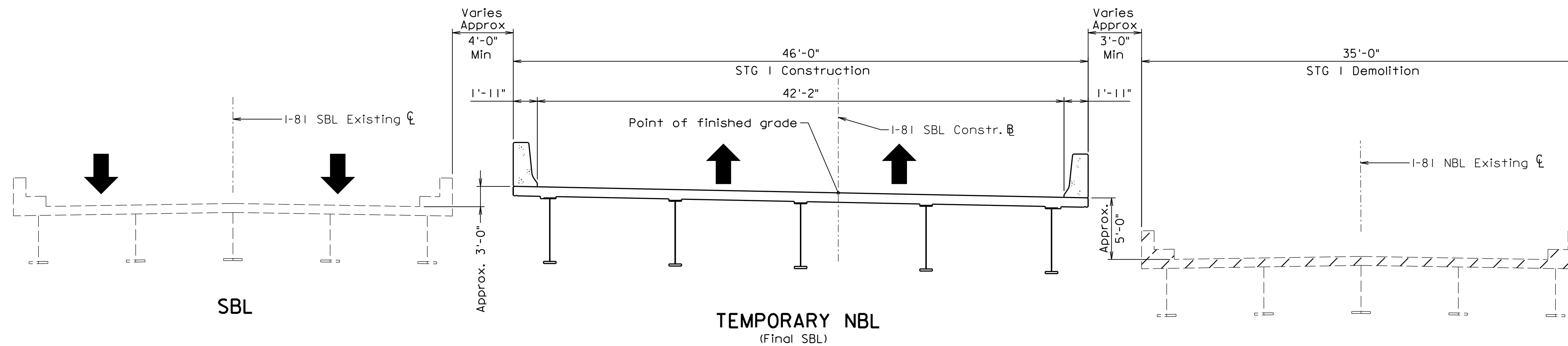

STAGE I CONSTRUCTION/DEMOLITION
(Looking Upstation)

•Note:
After Stage I Construction is complete, direct NB traffic on new SB Bridge.
Then proceed with Stage I Demolition of existing NB Bridge.

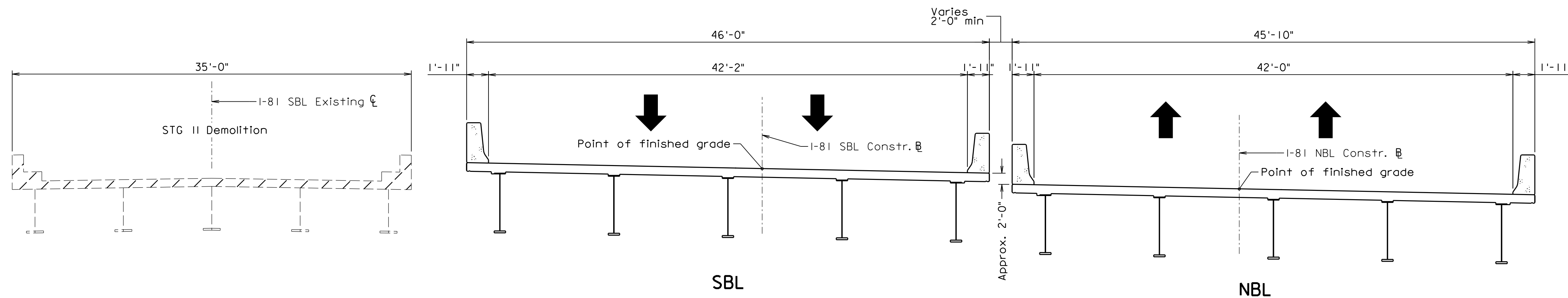

STAGE II CONSTRUCTION/DEMOLITION
(Looking Upstation)

•Note:
After Stage II Construction is complete, direct SB traffic on new SB bridge and
direct NB traffic on new NB Bridge. Then proceed with Stage II Demolition of
existing SB Bridge.

PRELIMINARY PLANS
THESE PLANS NOT TO BE USED
FOR CONSTRUCTION

AMT, INC
ROCKVILLE, MD
STRUCTURAL ENGINEER

COMMONWEALTH OF VIRGINIA DEPARTMENT OF TRANSPORTATION			
STRUCTURE AND BRIDGE DIVISION			
STAGE CONSTRUCTION			
No.	Description	Date	Revisions
Designed: ZG	Date	Plan No.	Sheet No.
Drawn: JAW	Feb 2018	296-64	2 of 5
Checked: MAM			

© 2014, Commonwealth of Virginia

STATE	FEDERAL AID		STATE	SHEET
ROUTE	PROJECT	ROUTE	PROJECT	NO.
VA.	NHPP-081-2(992)	I-81	0081-154-733,B601, B616	3

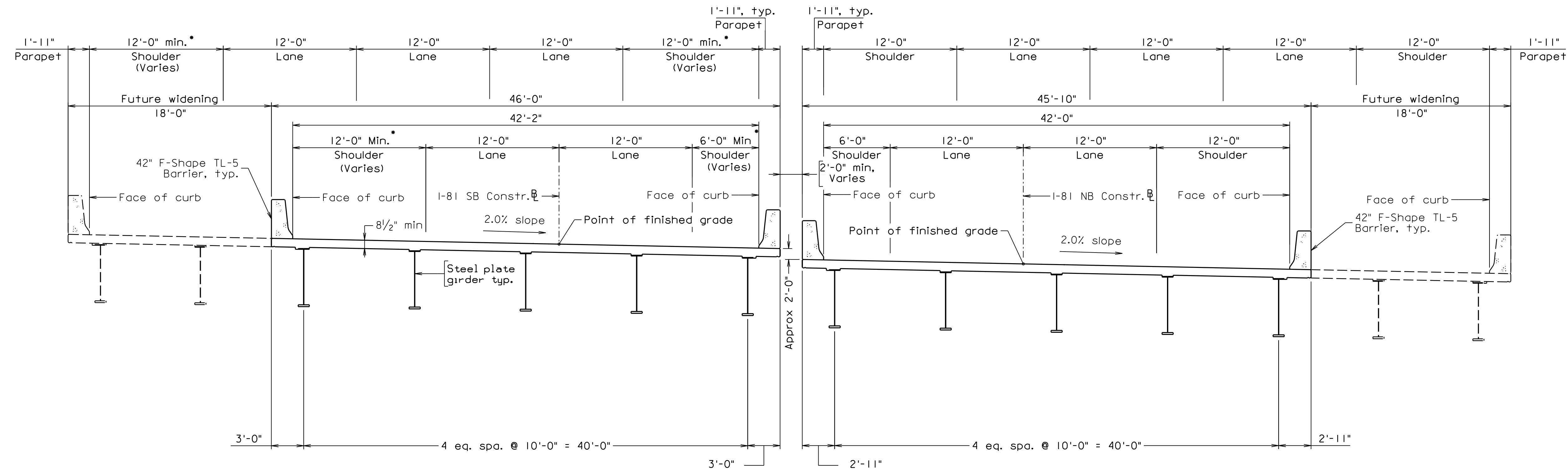

• Note: Shoulder width varies on the bridge because of the curvature of the horizontal alignment. Curb to curb is a constant 42'-2" width, 2" more than RFP plans, to accommodate this slight curvature. There is a minimum of 12 feet carried on the outside shoulder, and a minimum of 6 feet carried on the inside shoulder.

TRANSVERSE SECTION

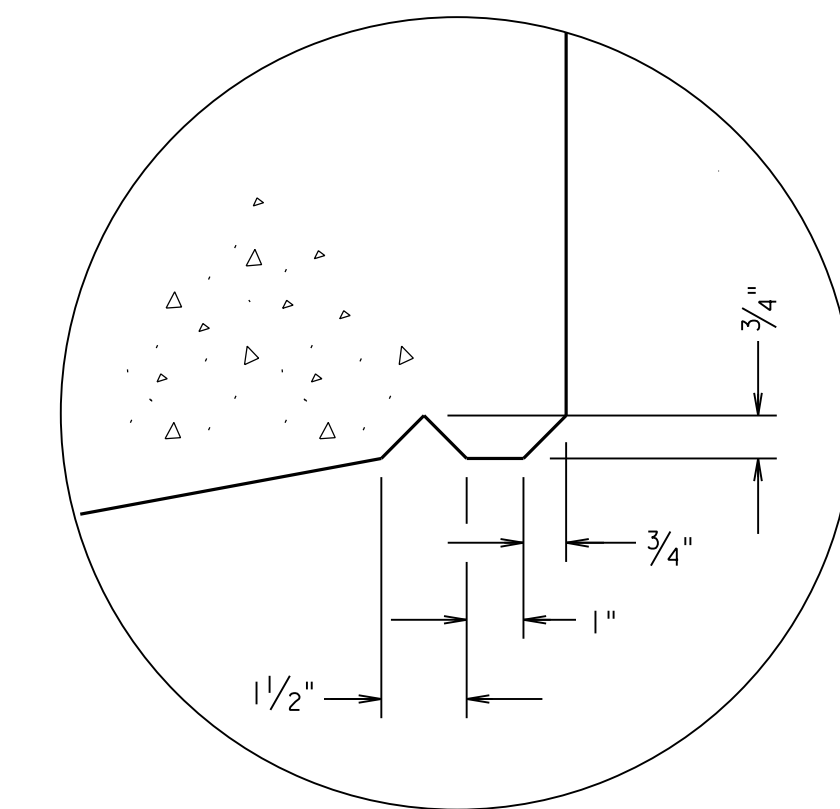

DRIP NOTCH
NOT TO SCALE

\$FILES\$

PRELIMINARY PLANS
THESE PLANS NOT TO BE USED
FOR CONSTRUCTION

AMT, INC
ROCKVILLE, MD
STRUCTURAL ENGINEER

COMMONWEALTH OF VIRGINIA DEPARTMENT OF TRANSPORTATION					
STRUCTURE AND BRIDGE DIVISION					
TRANSVERSE SECTION					
No.	Description	Date	Designed: ...ZG...	Date	Plan No.
			Drawn: ...MAW...	Feb 2018	296-64
			Checked: ...MAW...		3 of 5
Revisions					

© 2014, Commonwealth of Virginia

STATE	FEDERAL AID		STATE	SHEET
ROUTE	PROJECT	ROUTE	PROJECT	NO.
VA.	NHPP-081-2(992)	81	0081-154-733, B601, B616	4

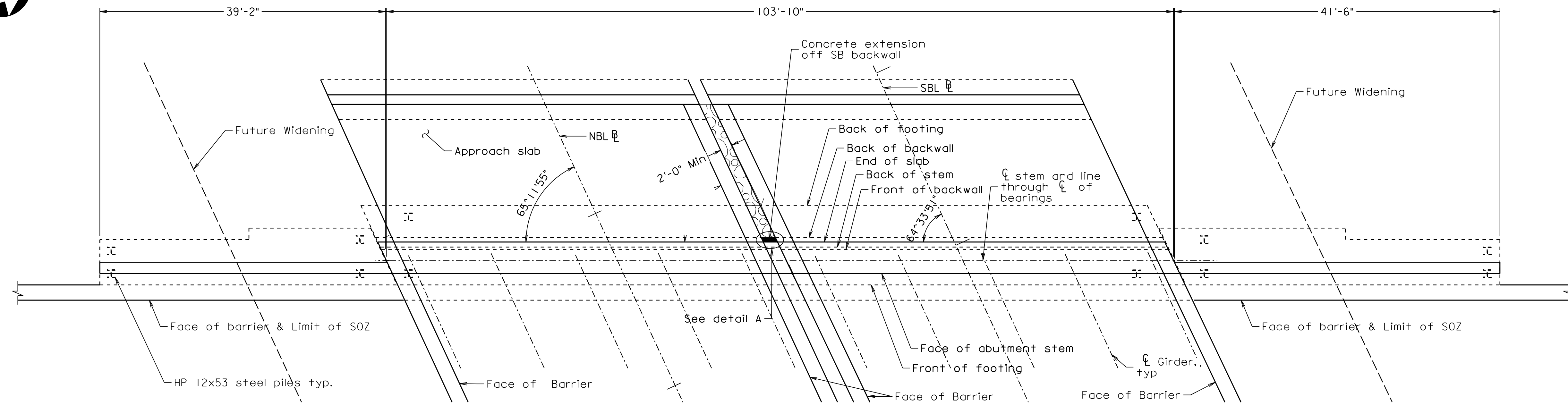
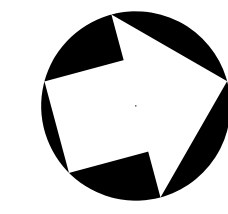

PLAN
(Abutment A shown, Abutment B similar)

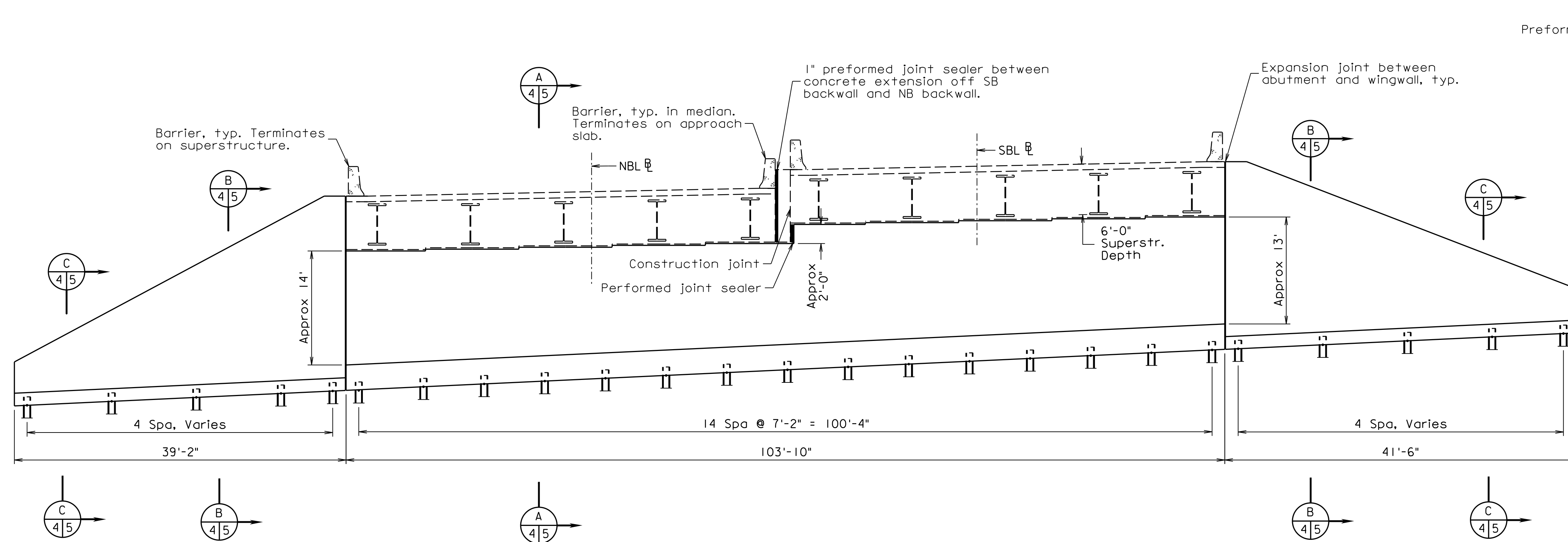

ELEVATION
(Abutment A shown, Abutment B similar)

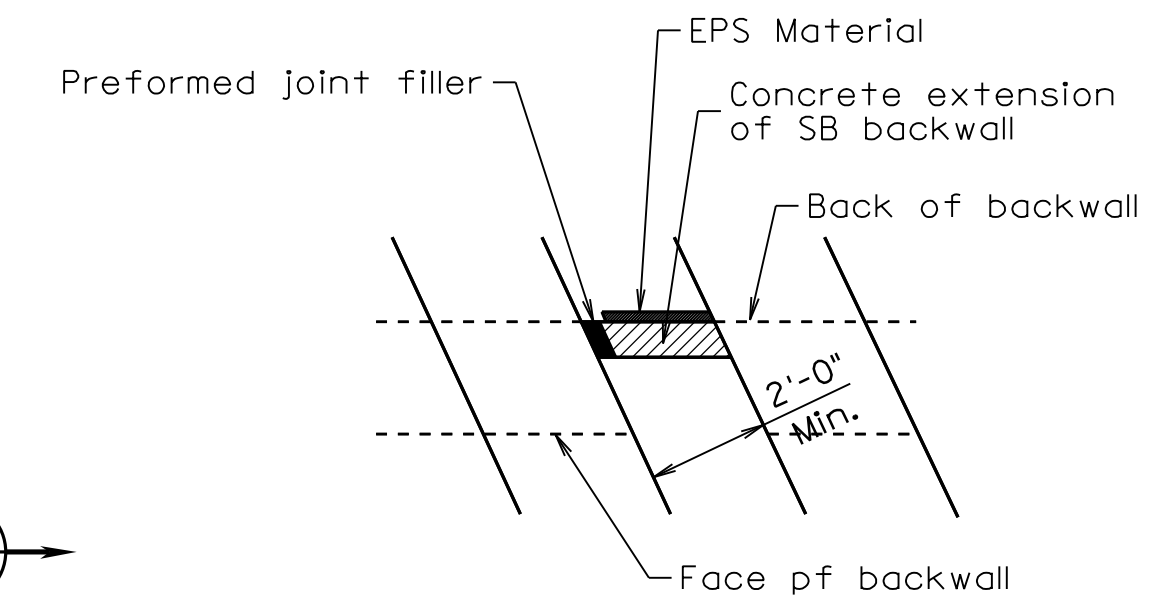

DETAIL A
Scale: 3/8" = 1'-0"

\$FILES\$

PRELIMINARY PLANS
THESE PLANS NOT TO BE USED
FOR CONSTRUCTION

AMT, INC
ROCKVILLE, MD
STRUCTURAL ENGINEER

COMMONWEALTH OF VIRGINIA DEPARTMENT OF TRANSPORTATION STRUCTURE AND BRIDGE DIVISION			
ABUTMENT ELEVATION AND PLAN			
No.	Description	Date	Designed: ZG..... Date: Drawn: Checked: MAM.....
			Feb 2018
			296-64
			4 of 5

Scale: 1/8" = 1'-0" unless otherwise noted

© 2018, Commonwealth of Virginia

STATE	FEDERAL AID		STATE	SHEET
ROUTE	PROJECT	ROUTE	PROJECT	NO.
VA.	NHHP-081-2(992)	81	0081-154-733, B601, B616	5

SEQUENCE OF CONSTRUCTION

- 1 - Drive Piles
- 2 - Build Footing of Barrier
- 3 - Build Pile Cap
- 4 - Build Abutment/ Wingwall
- 5 - Build Barrier
- 6 - Fill Space between Barrier & Abutment/Wingwall

PRELIMINARY PLANS
THESE PLANS NOT TO BE USED FOR CONSTRUCTION

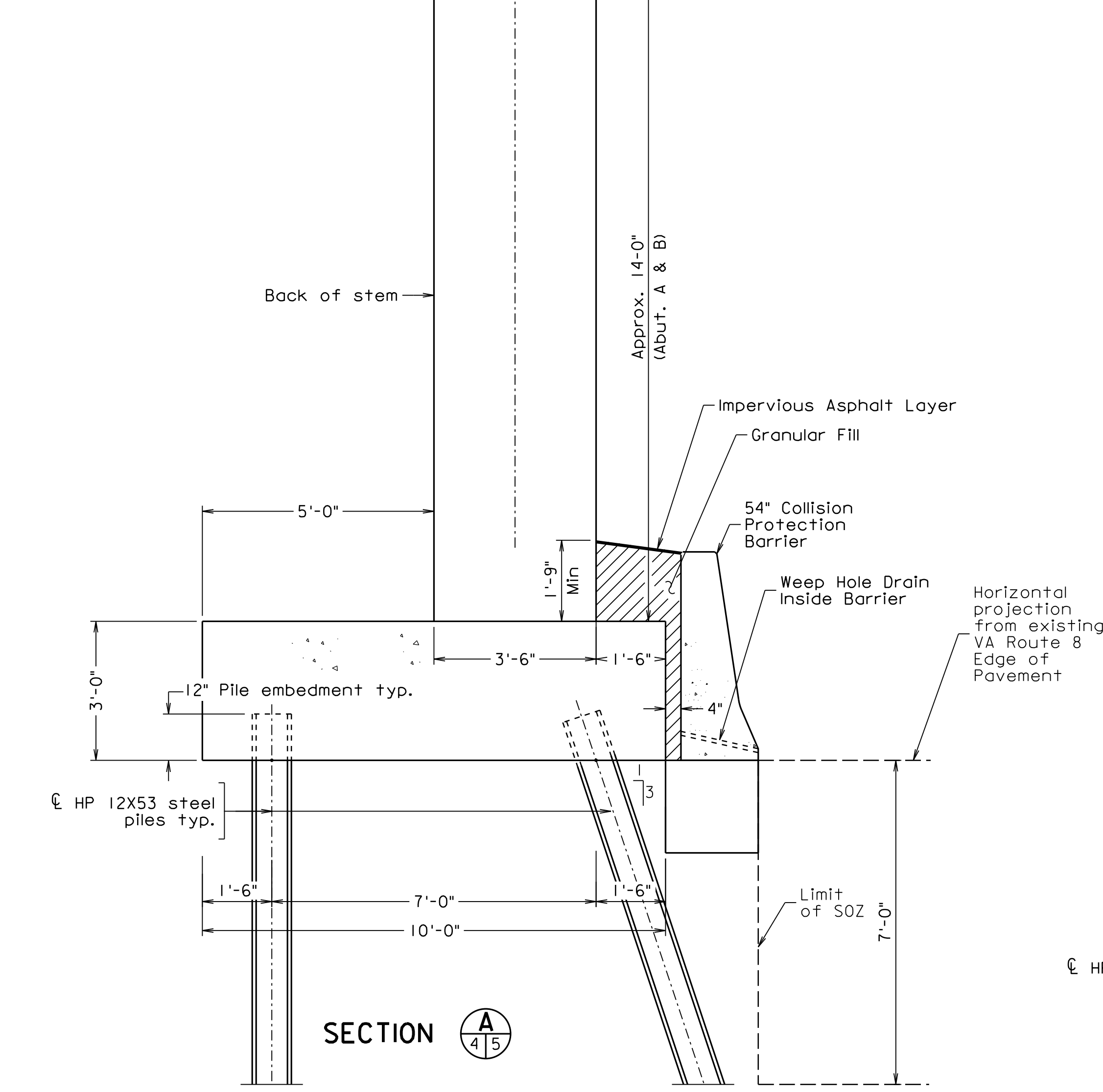
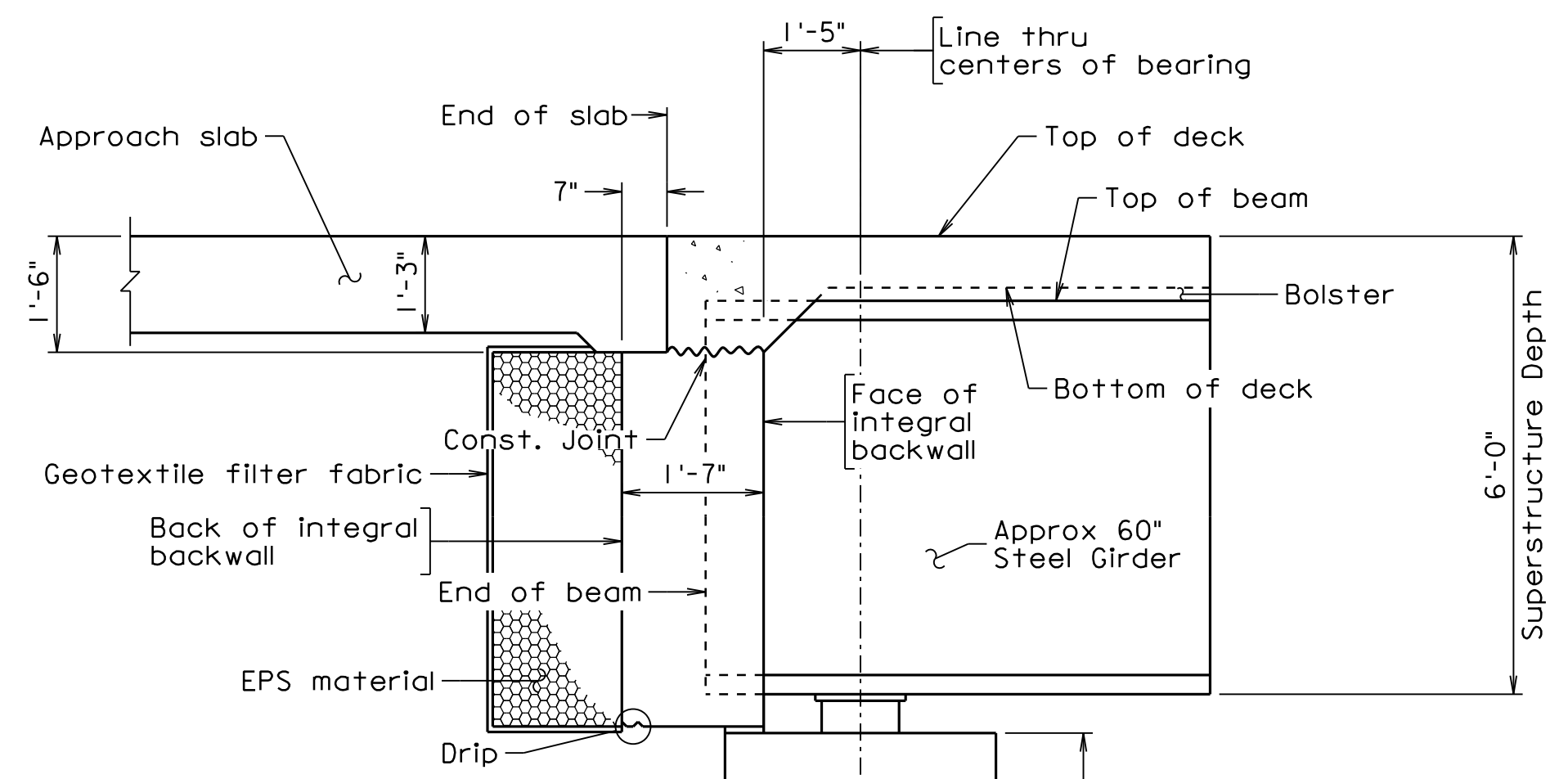

Preliminary Pile Layout	
Number of Rows	2
Spacing (ft)	7'-2"
Total No of Piles	30

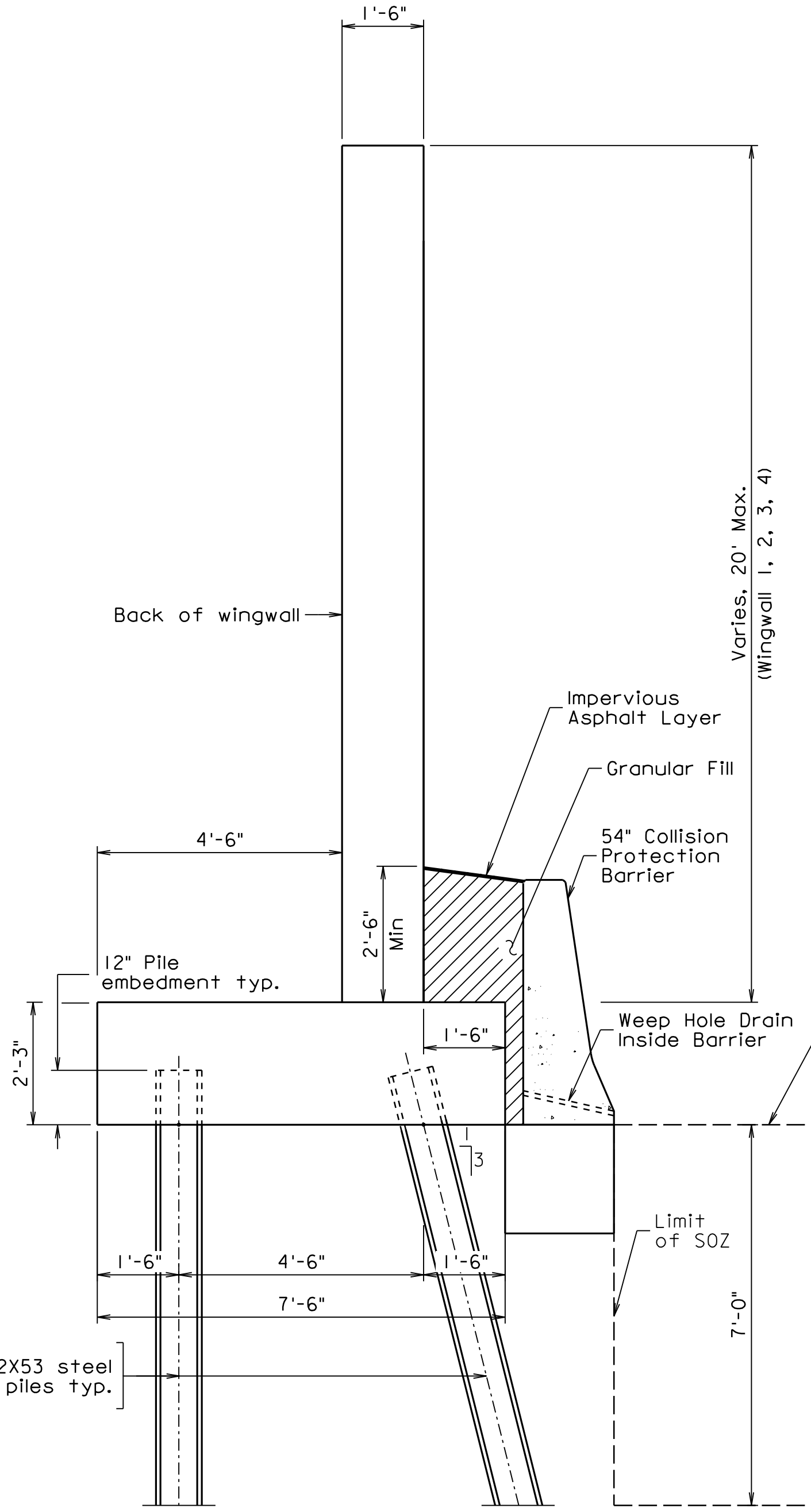

Preliminary Pile Layout	
Number of Rows	2
Spacing (ft)	8'-6"
Total No of Piles	6

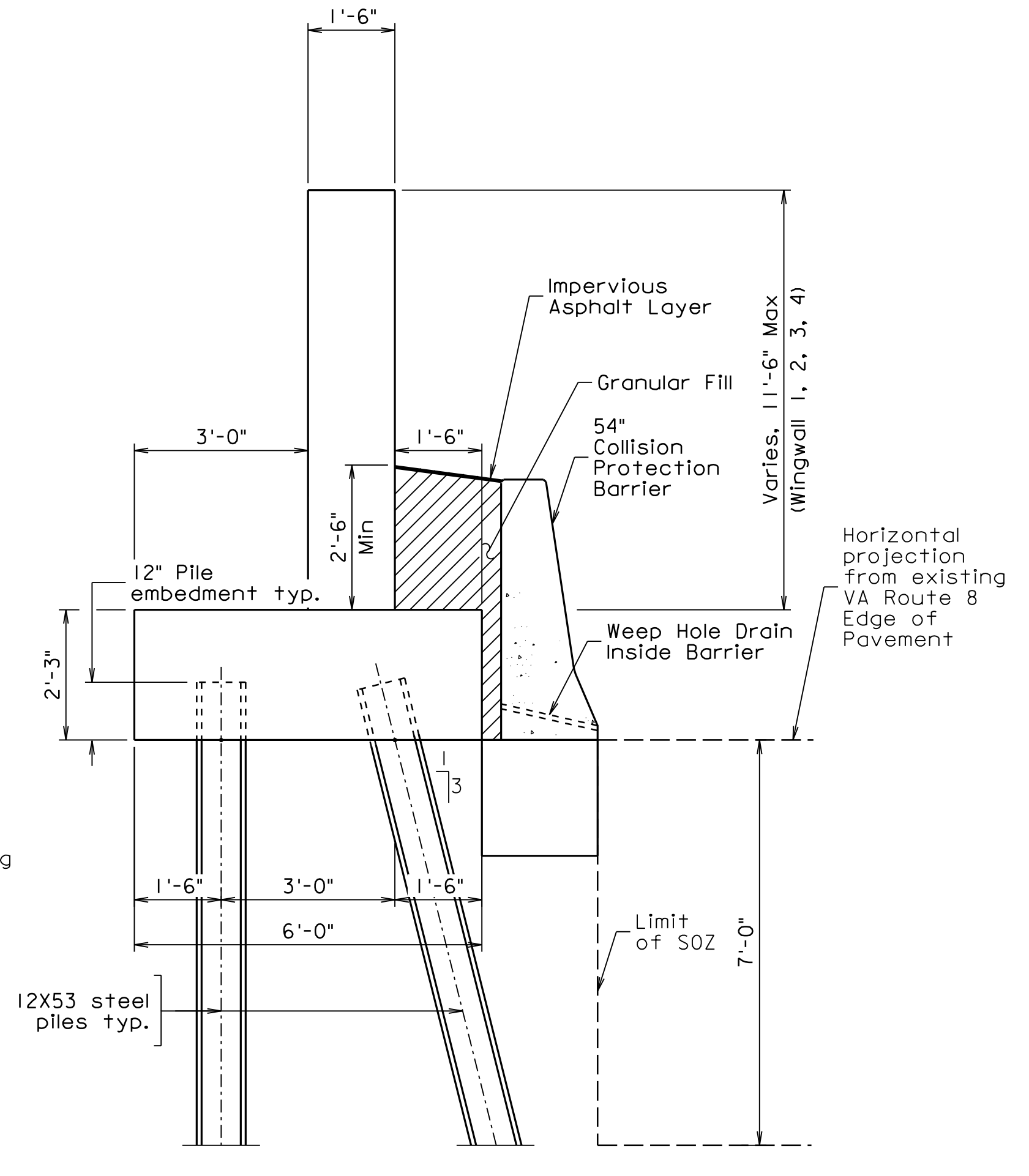

WINGWALL SECTION C

Preliminary Pile Layout	
Number of Rows	2
Spacing (ft)	10'-0"
Total No of Piles	4

\$FILES\$

AMT, INC
ROCKVILLE, MD
STRUCTURAL ENGINEER

COMMONWEALTH OF VIRGINIA DEPARTMENT OF TRANSPORTATION					
STRUCTURE AND BRIDGE DIVISION					
ABUTMENT SECTIONS					
No.	Description	Date	Designed: HZ	Date	Plan No.
			Drawn: MW	Feb 2018	296-64
			Checked: MW		5 of 5